



# **TUŠ KABINE**

## SHOWER ENCLOSURES



# 05

Shower enclosure  
Duschkabinen  
Душевые кабины  
Zuhanyfülkék

## Dynamics of shower enclosure

We opt for a shower enclosure due to the fast pace of life, lack of space, lower water consumption and lower footprint on the environment. Kolpasan shower enclosures help us make the most of the bathroom, optically enlarge it, and facilitate daily cleaning. By choosing the right model and glass, even the tiniest of spaces will be visually enlarged so we won't feel cramped, but safe and relaxed.

## Dynamik der Duschkabine

Für Duschkabinen entscheiden wir uns aufgrund des hektischen Lebensrhythmus, Platzmangel, kleineren Wasserverbrauch und des geringeren ökologischen Fußabdrucks. Die Duschkabinen Kolpasan helfen uns, unser Badezimmer optimal zu nutzen, es optisch zu vergrößern und die tägliche Reinigung zu erleichtern. Durch die Wahl des richtigen Modells und Glases erweitert sie optisch auch einen kleinen Raum, sodass wir uns nicht eingeengt, sondern sicher und entspannt fühlen.

## Динамика душевой кабины

Мы выбираем душевую кабину из-за быстрого ритма жизни, нехватки места, экономии потребления воды и меньшего воздействия на окружающую среду. Душевые кабины Kolpasan помогают нам максимально использовать пространство в ванной комнате, оптически увеличить ванную комнату, а также облегчают ежедневную уборку. Правильный подбор модели и стекла зрительно расширяет даже небольшое пространство, чтобы мы чувствовали себя не стесненно, а безопасно и расслабленно.

## A zuhanyfülkék dinamikája

Zuhanyfülkét a gyors életritmus, a helyhiány, az alacsonyabb vízfogyasztás és a kisebb környezeti lábnyom miatt választunk. A Kolpasan zuhanyfülkékkel javíthatjuk a fürdőszoba helykihasználását, tágasabbá tehetjük a fürdőszobát és megkönnyíthetjük a mindennapi takarítását. A megfelelő modell és üveg kiválasztásával vizuálisan megnyitja a kis teret is, s így nem érezzük szűknek, hanem biztonságosnak és nyugodtnak.



**5**  
years warranty  
Jahre Garantie

**3**  
years warranty  
Jahre Garantie



\* SQ line, Eco Quat



# 05

132

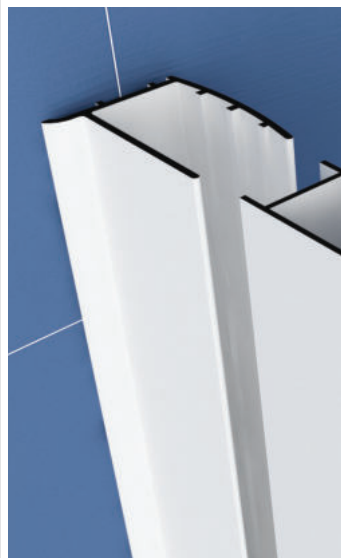
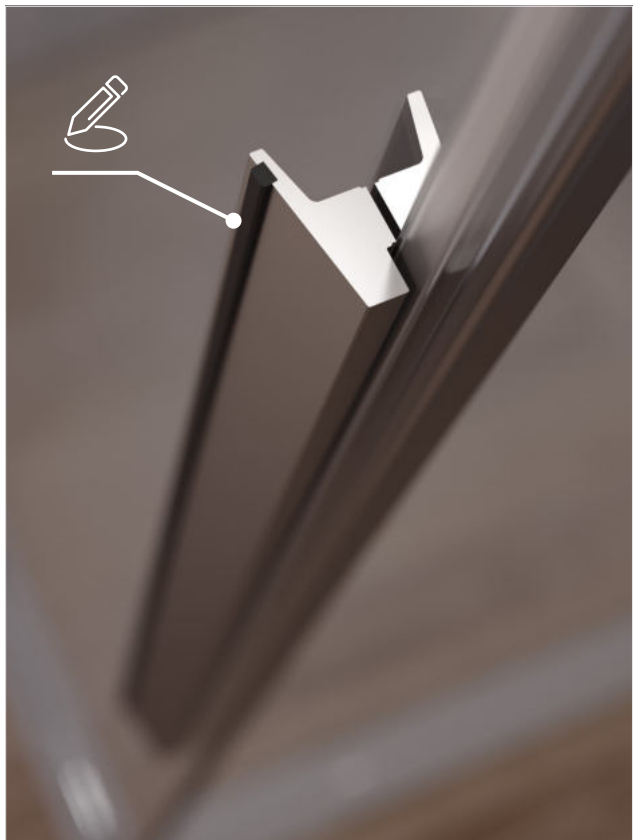
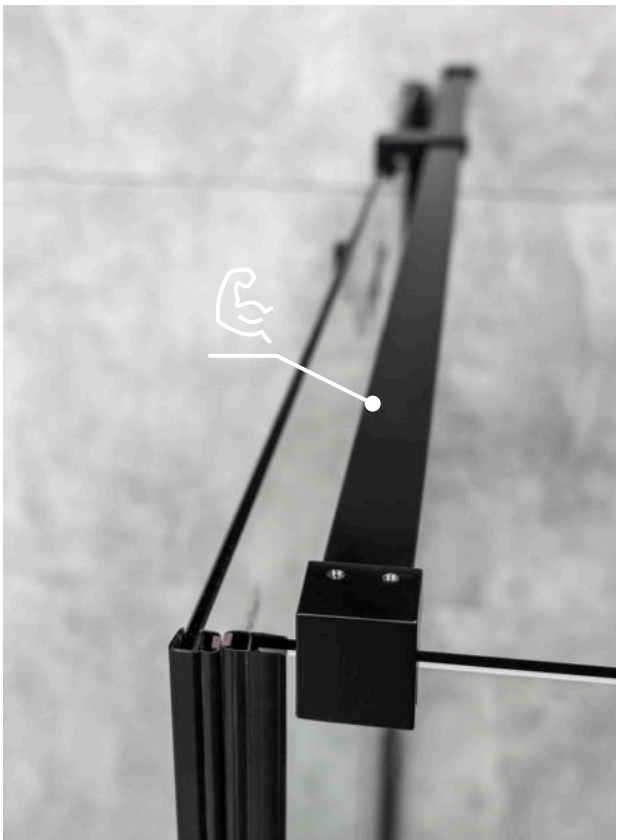
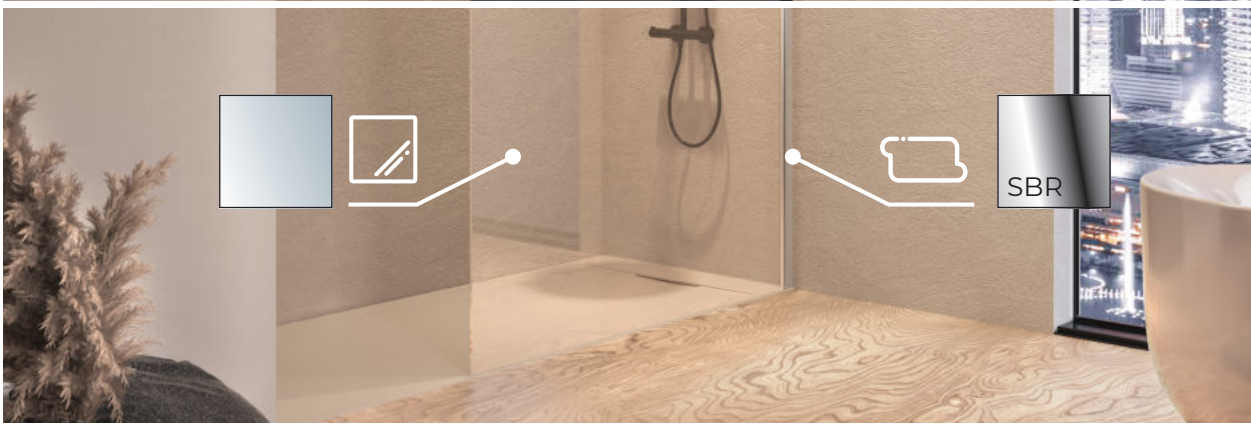
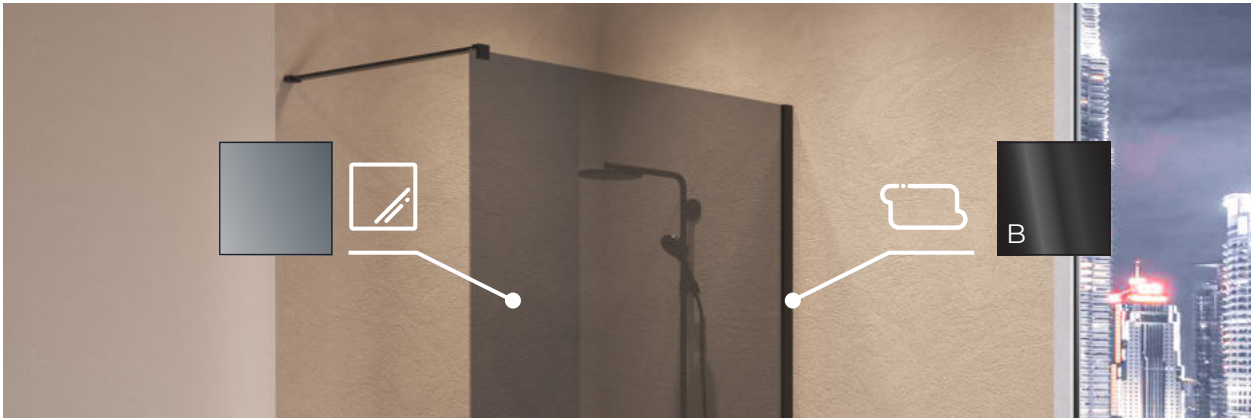

Info

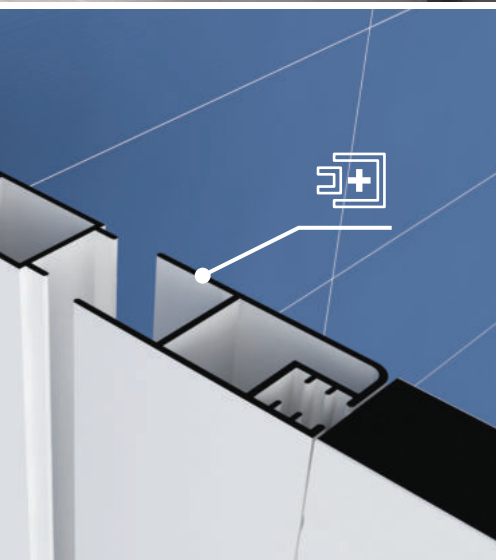

# SHOWER ENCLOSURES DUSCHKABINEN ДУШЕВЫЕ КАБИНЫ ZUHANYFÜLKÉK



- choose between different types of glass and profiles
- Möglichkeit der Auswahl verschiedener Glasarten und Profile
- возможность выбора различных видов стекла и профилей
- különféle üvegtípusok és profilok választhatók



- contemporary designed shower enclosures of pure geometric shapes with a robust construction
- modern gestaltete Duschkabinen mit reinen geometrischen Formen und robuster Konstruktion
- современный дизайн душевых кабин с чистыми геометрическими формами и прочной конструкцией
- modern kialakítású, tiszta geometriai formájú zuhanykabinok robusztus konstrukcióval



- our products allow 4 different installation options
- unsere Produkte ermöglichen 4 verschiedene Einbaumöglichkeiten
- наши изделия допускают 4 различных варианта установки
- termékeink 4 különböző beépítési lehetőséget tesznek lehetővé

100

- more than 100 models of shower enclosures for the equipment of a wide range of bathrooms
- mehr als 100 Modelle von Duschwannen für die Ausstattung verschiedener Arten von Badezimmern
- более 100 моделей душевых поддонов для оборудования различных типов ванных комнат
- több mint 100 zuhanytálca modell különféle típusú fürdőszobák felszereléséhez



- possibility of adjusting the shape of certain models
- bei bestimmten Modellen kann die Form angepasst werden
- возможность корректировки формы у некоторых моделей
- egyes modellek alakja az igényekhez igazítható



- possibility of implementing non-standard dimensions with additional compensation profiles
- die Möglichkeit der Ausführung von nicht standardmäßige Abmessungen mit zusätzlichen Ausgleichprofilen
- возможность реализации нестандартных размеров с дополнительными компенсационными профилями
- a nem szabványos méretek megvalósításának lehetősége további kompenzációs profilokkal



**A range of shower enclosures and their characteristics**

Familie der Duschkabinen und ihre Eigenschaften  
 Семья душевых кабин и их характеристики  
 Zuhanykabin termékcsaládok és tulajdonságaik



**Polaris**

> 140



**Polaris fold**

> 146



**Andromeda**

> 152



**Atlas**

> 160

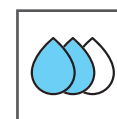

**Calypso**

> 168



**Virgo UNI**

> 172

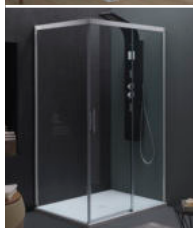

**Montes**

> 176



**Dorsa UNI**

> 180

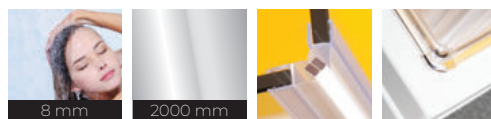



## A range of shower enclosures and their characteristics

Familie der Duschkabinen und ihre Eigenschaften

Семьи душевых кабин и их характеристики

Zuhanykabin termékcsaládok és tulajdonságaik



### Pulsar

> 184

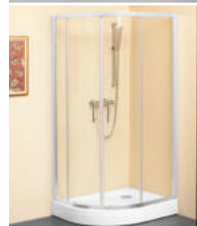

### SQ line

> 192

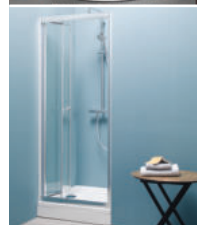
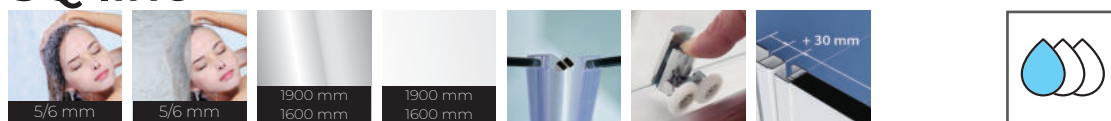

### Luna

> 204



### Eco Quat

> 212



### Polaris

> 216



### Andromeda

> 220



### Sole

> 224

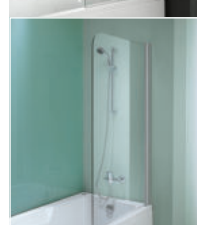

### Quat

> 228





### Shower enclosures - shapes and sizes

Duschkabinen - Formen und Maße

Душевые кабины - таблица форм и установки

Zuhanyfülkék - áttekintés forma és kialakítás alapján

range Programm программа program										
Andromeda										
Polaris										
Polaris Fold										
Calypso										
Atlas										
Virgo UNI										
Montes										
Dorsa										
Pulsar										
SQ line										
Luna										
Eco Quat										
Sole										
Quat										

Info

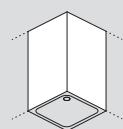

corner  
Eckaufstellung  
угловая установка  
sarkos kivitelezés

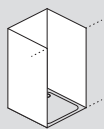



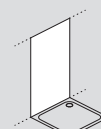





recessed  
Nischenaufstellung  
установка в нише  
kivitelezés fülkében

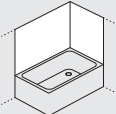

wall  
Aufstellung an der Wand  
установка у стены  
falmelletti kivitelezés





range Programm программа program										
Andromeda	 BS 120	 BS 80								
Polaris	 BS 80									
Polaris Fold										
Calypso										
Atlas										
Virgo UNI										
Montes										
Dorsa										
Pulsar										
SQ line										
Luna										
Eco Quat										
Sole	 TP 104 UNI	 TP 102 UNI								
Quat	 TP 108, 105 UNI	 TP 80 UNI								

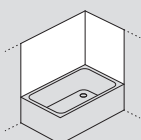

corner  
Eckaufstellung  
угловая установка  
sarkos kivitelezés



## Factors affecting water tightness of shower cabins according to models

Faktoren, die die Wasserdichtheit der Duschkabinen beeinflussen, nach Modellen

Факторы водонепроницаемости душевых кабин - модели

Zuhanykabinok vízhatlansági tényezői típusonként



Despite the sealants on my shower enclosure, the water still leaks. Is this normal?  
Trotz Dichtungen an der Duschkabine läuft das Wasser noch immer aus. Ist das normal?  
Несмотря на герметик вода из душевой кабины вытекает. Разве это нормально?  
A tömítések ellenére a zuhanykádából továbbra is kifolyik a víz. Ez normális?

Shower enclosures come in various levels of water resistance. However, nobody can ensure total protection against water leakage.

Duschkabinen bieten verschiedene Dichtheitsstufen an, aber ein vollständiger Schutz gegen das Auslaufen von Wasser kann nicht garantiert werden.

Существуют душевые кабины с различным уровнем герметичности, однако полную герметичность гарантировать невозможно.

A zuhanykabinok különböző tömítéseket, szigeteléseket kínálnak, a víz teljes megállítása azonban nem lehetséges.

### F 1

#### Factor 1

##### Shower cabin models featuring an aluminium frame

These models feature particularly good water tightness characteristics and are recommended for more frequent showers and use of massage showers consuming large quantities of water.

#### Faktor 1

##### Modelle von Duschkabinen mit Aluminiumrahmen

Diese Modelle ermöglichen besonders gute Wasserdichtheitseigenschaften. Sie werden empfohlen für häufiges Duschen und Benutzung von Massageduschen mit großen Mengen von Wasser.

#### Фактор 1

##### Модели душевых кабин с алюминиевой рамкой

Эти модели имеют очень хорошие водонепроницаемые свойства. Рекомендуются для частого употребления и массажа с большим количеством воды.

#### 1-es faktor

##### Alumínium keretű zuhanykabin típusok

Ezek a típusok különösen jó vízhatlansági tulajdonságokkal bírnak. A nagyobb gyakorisággal használt, illetve a nagyobb vízfogyasztású masszázszuhanyok esetében ajánlatosak.

### F 2

#### Factor 2

##### Shower cabin models with an additional protection profile

Additionally installed profile improves the water tightness protection level, but it cannot guarantee it 100 %.

#### Faktor 2

##### Modelle von Duschkabinen mit zusätzlichem Schutzprofil

Das zusätzlich montierte Profil verbessert den Grad der Wasserdichtheit, natürlich kann das aber nicht 100 % garantiert werden.

#### Фактор 2

##### Модели душевых кабин с дополнительным защитным профилем

Дополнительно установленный профиль повышает уровень водонепроницаемости, но не гарантирует 100% герметичность.

#### 2-es faktor

##### Zuhanykabinok kiegészítő védőprofilal

A kiegészítő profil növeli a vízhatlanságot, de nem tudja ezt 100% -ban biztosítani.

### F 3

#### Factor 3

##### Shower cabin models without an aluminium frame

They provide a satisfactory water tightness protection level. Since the bottom frame is missing, water can more easily leak out. Nevertheless, these cabin models are elegant, exclusive and are easier to clean.

#### Faktor 3

##### Modelle von Duschkabinen in der Ausführung ohne Aluminiumrahmen

Sie haben einen zufriedenstellenden Grad der Wasserdichtheit. Aufgrund des fehlenden unteren Rahmens kann das Wasser leichter abfließen. Trotzdem sind die Kabinenmodelle elegant, exklusiv und ermöglichen eine einfache Reinigung.

#### Фактор 3

##### Модели душевых кабин без алюминиевой рамки

Эти модели имеют удовлетворительный уровень водонепроницаемости. В связи с отсутствием нижней рамки, существует возможность утечки воды. Тем не менее, эти модели кабин элегантны, эксклюзивны и просты в очистке.

#### 3-as faktor

##### Zuhanykabin típusok alumíniumkeret nélkül

Elfogadható vízhatlansági tulajdonságokkal bírnak. A hiányzó alsó keret miatt a víz könnyebben kifolyik. Ennek ellenére ezek a típusok elegánsak, exkluzív kivitelezésűek és könnyebben tisztíthatók.

Cabins with the bottom frame  
Duschkabinen mit Unterrahmen  
Кабины с нижней рамкой  
Kiegészítő védőprofil



F 1

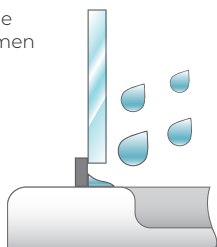

Additional protection profiles  
Zusätzliches Schutzprofil  
Дополнительный защитный  
профиль  
Kiegészítő védőprofil



F 2

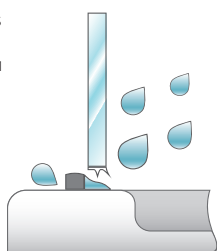

Cabins without a frame  
Rahmenlose Duschkabinen  
Кабины без рамки  
Keret nélküli kabinok



F 3



The design of the shower screens determines the water tightness. The basic rule: the larger and taller the middle profile, the higher the protection level.  
Das Design der Duschabtrennungen bestimmt den Grad der Wasserdichtheit. Eine Grundregel lautet: Je größer und höher das untere Profil ist, desto höher ist die Schutzstufe.  
Дизайн душевых заслонок определяет уровень водонепроницаемости. Основное правило: чем больше и выше нижний профиль, тем выше уровень защиты.  
A zuhanykabinok vízhatlanságát elsősorban a design határozza meg. Az alapszabály: minél nagyobb és magasabb az alsó profil, annál nagyobb a védelem foka.





## FAQ - Massage and Shower Enclosures

Häufig gestellte Fragen: Massage- und Duschkabinen

Часто задаваемые вопросы - массажные и душевые кабины

Gyakori kérdések - masszázs-és zuhanykádák

139



What are the advantages of Clean Coat-protected glass for shower enclosures?  
 Welche Vorteile bringt der Clean Coat Scheibenschutz für Duschkabinen?  
 Каковы преимущества защиты стеклянных поверхностей Clean Coat в душе?  
 Milyen előnnyel jár az üvegvédelem Clean Coat a zuhanykabinok esetében?

**kolpa** Clean Coat

Advantages of shower enclosure glass-protection:

- **Aesthetics:** clean and shiny appearance that lasts longer; the resistance to dirt, stains and dark blotches prolongs its original appearance.
  - **Functionality:** extremely easy to clean
  - **Hygienic aspect:** enables faster rinsing, to remove dirt, salt and bacteria, and leaves no deposits and remains. If the glass is exposed to water for a longer period of time, it facilitates removal of deposited dirt through multiple washing.
  - **Ecological aspect:** reduces use of more aggressive cleaning agents.
- Coating can be applied either to new or used surfaces.



Vorteile des Scheibenschutzes bei Duschkabinen

- **ästhetische:** sauberes und glänzendes Aussehen, das länger anhält; aufgrund der Widerstandsfähigkeit gegen Schmutz, Flecken und Nachdunkelung, wird das ursprüngliche Aussehen verlängert
  - **funktionale:** ermöglicht eine sehr einfache Reinigung
  - **hygienische:** ermöglicht schnelles Abspülen, das Schmutz, Salz sowie Bakterien entfernt und keine Ablagerungen und Rückstände hinterlässt; ist die Glasoberfläche über längere Zeit hinweg Wasser ausgesetzt, erleichtert er die Entfernung von abgelagertem Schmutz durch mehrfaches Waschen
  - **ökologische:** geringerer Verbrauch an aggressiven Reinigungsmitteln
- Die Versiegelung kann sowohl auf neue als auch auf gebrauchte Oberflächen aufgetragen werden.

Преимущества защиты стеклянных поверхностей в душе:

- **эстетические:** чистый и блестящий вид, который длится долгое время. Благодаря устойчивости к грязи, пятнам и потемнению продлевается первоначальный вид
- **функциональные:** очень легкая очистка
- **гигиенические:** быстрое споласкивание, удаляющее грязь, соль, бактерии и не оставляющее отложений и остатков. В случае, если стеклянная поверхность длительное время подвергалась воздействию воды, то удаление грязи проводится с помощью повторной промывки.
- **эстетические:** чистый и блестящий вид, который сохраняется долгое время. Благодаря устойчивости к грязи, пятнам и потемнению поддерживается первоначальный вид

Az üvegvédelem előnyei:

















- **esztétikailag** tiszta és fényes, tartósabb üveg. Ellenáll a kosznak, foltoknak, és az elsötétedésnek is, így tovább tűnik újszerűnek.
  - **funkcionálisan** igen egyszerű, igen könnyen tisztítható.
  - **higiénikusabb**, mivel gyorsabb öblítést tesz lehetővé, így gyorsabban szabadulunk meg a kosztól, a sótól és a baktériumoktól is, nem maradnak lerakódások, illetve ezek jóval könnyebben tisztíthatók.
  - **ökológiailag** hatékonyabb, nem követel agresszív szereket.
- A védőréteg az új és a használt felületen is alkalmazható.

140

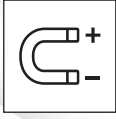
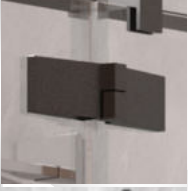

Polaris

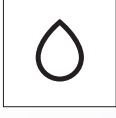
# POLARIS

 <b>8/6 mm</b>	<p><b>8/6 mm transparent tempered glass</b>        8/6 mm transparentes gehärtetes Glas        8/6 мм прозрачное закаленное стекло        8/6 mm átlátszó edzett üveg</p>	 
 <b>2000 mm</b>	<p><b>Silver Brill Studs (high gloss-polished silver galvanised coating)</b>        Silber Brill Profile (hochglanzpolierte silberne galvanische Beschichtung)        Серебристые профили бриллиант (серебряное гальваническое покрытие высококачественной полировки)        Ezüst Brill profilok (magas fényezésű ezüst galvanizált burkolat)</p>	 
 <b>2000 mm</b>	<p><b>BLACK profiles, powder coating</b>        BLACK (schwarze) Profile, staublackiert        BLACK (черные) профили, порошковое покрытие лаком        BLACK (fekete) profilok, porlakkozás</p>	 
 <b>magnetic edge closure</b>	<p><b>Magnetprofil-Verschluss</b>        закрытие с магнитным профилем        zárás mágneses profilal</p>	
 <b>hinges with lifting function</b>	<p><b>Scharniere mit Hubfunktion</b>        петли с функцией подъема        zsanérok emelő funkcióval</p>	
 <b>support for the stability of the shower enclosure</b>	<p><b>Stütze für die Stabilität der Duschkabine</b>        опора для устойчивости душевой кабины        támaszték a zuhanyfülke stabilizálásához</p>	
 <b>an additional aluminium edge on the shower tray prevents overflow</b>	<p><b>ein zusätzliches Alu-Profil auf der Duschwanne verhindert das Auslaufen von Wasser</b>        дополнительные алюминиевые профили на поддоне, предотвращающие утечку воды        kiegészítő alumínium profil, amely megakadályozza a víz kifolyását</p>	
 <b>Clean coat, protective coating</b>	<p><b>Clean coat, Schutzbeschichtung</b>        Clean coat защитное покрытие        Clean coat, védőbevonat</p>	

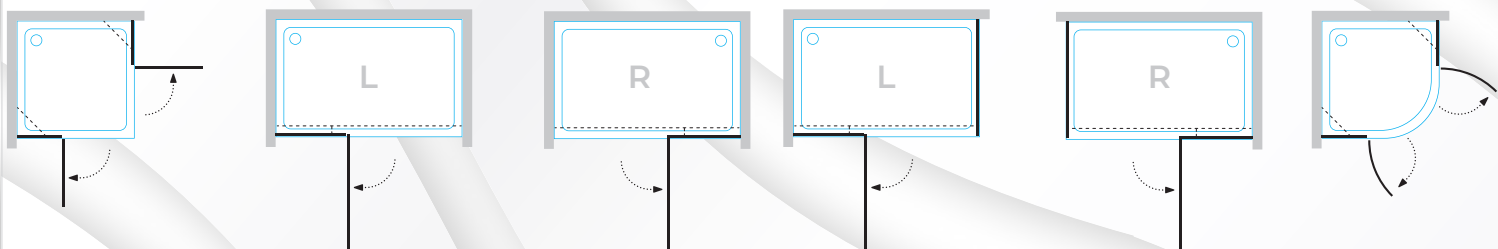

# Polaris Q 100, 90, 80

142

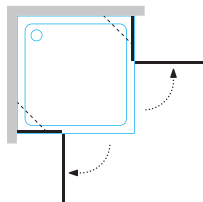

## Q 100, 90, 80

- Corner shower enclosure with double-wing doors.
- Eckduschkabine mit zweiflügelige eingehängte Türen.
- Угловая душевая кабина с двумя подвижными дверями на шарнирах.
- Négyszögletes zuhanykabin két egyenes ajtóval, zsanérokkal.

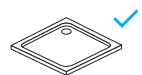
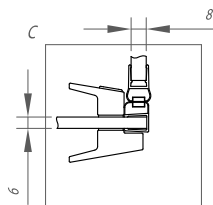
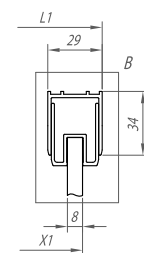
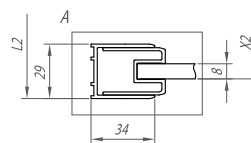
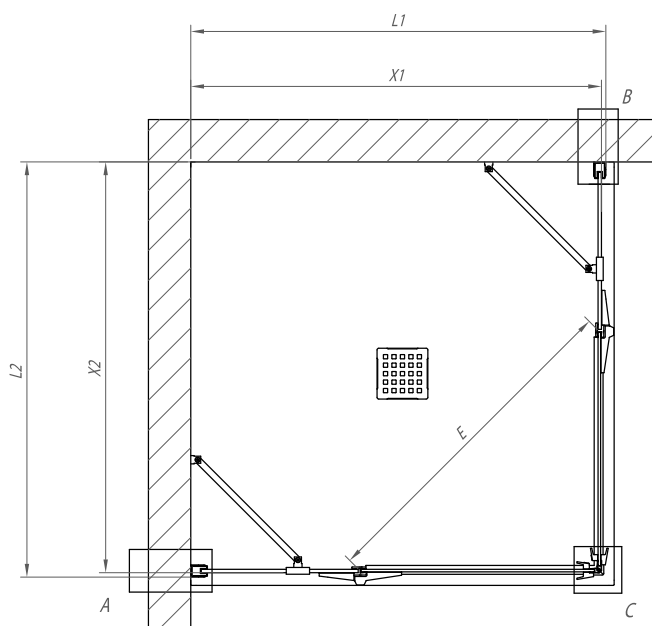

Tello, Lavolta, Lerock zero, Pandora Tray, Canary, Serra, Drop, Flamenco, Evelin Tray Q, Trin.

Polaris			L1	L2	X1	X2		E	
Q 100			980 - 990	980 - 990	970 - 980	970 - 980	2000	790	
Q 90			880 - 890	880 - 890	870 - 880	870 - 880	2000	790	
Q 80			780 - 790	780 - 790	770 - 780	770 - 780	2000	650	

# Polaris N 140, 120, 100, 90 - L,R

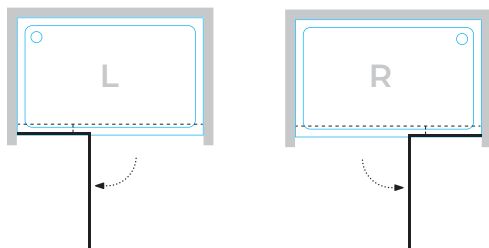

## N 140, 120, 100, 90 - L,R

- Self-supporting shower door, single-side opening.
- Gleittür 2-teilig mit Festfeld in Nische
- Самостоятельные двери для душевой кабины, односторчатое открывание
- Önálló zuhanyajtó, egyirányú nyitással.

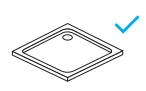
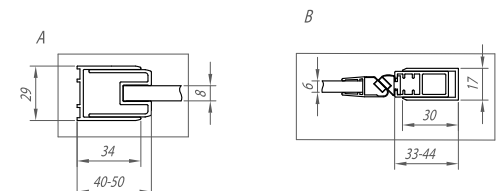
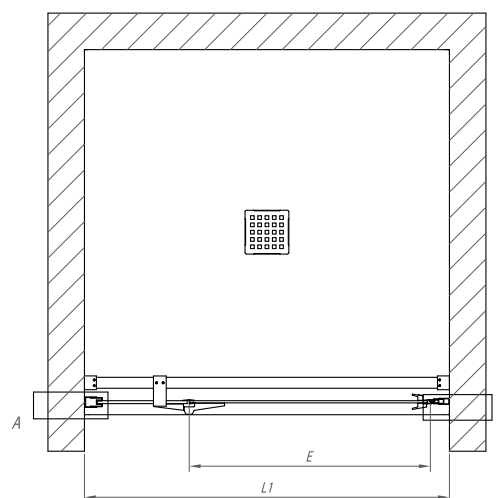

Ballo, Tello, Lavolta, Lerock zero, Ramona tray, Limbo, Re-walk, Acro, Pandora Tray, Canary, Serra, Drop, Flamenco, Funky, Evelin Tray Q, Trin.

Polaris			L1	L2	X1	X2		E	
N 140			1380 - 1400				2000	630	
N 120			1180 - 1200				2000	630	
N 100			980 - 1000				2000	630	
N 90			880 - 900				2000	530	

# Polaris D 140, 120, 100, 90, 80 + W 100, 90, 80

144

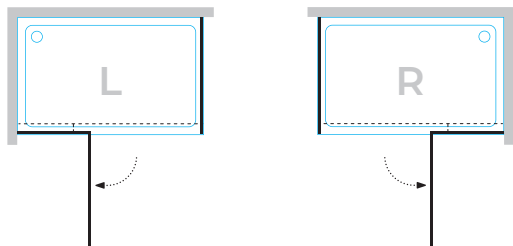

## D 140, 120, 100, 90, 80 + W 100, 90, 80

- Shower door with shower wall.
- Schwingtür mit Festfeld + Seitenwand.
- Душевые шторки с душевой панелью.
- Zuhanyajtó zuhanyfallal.

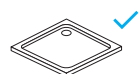
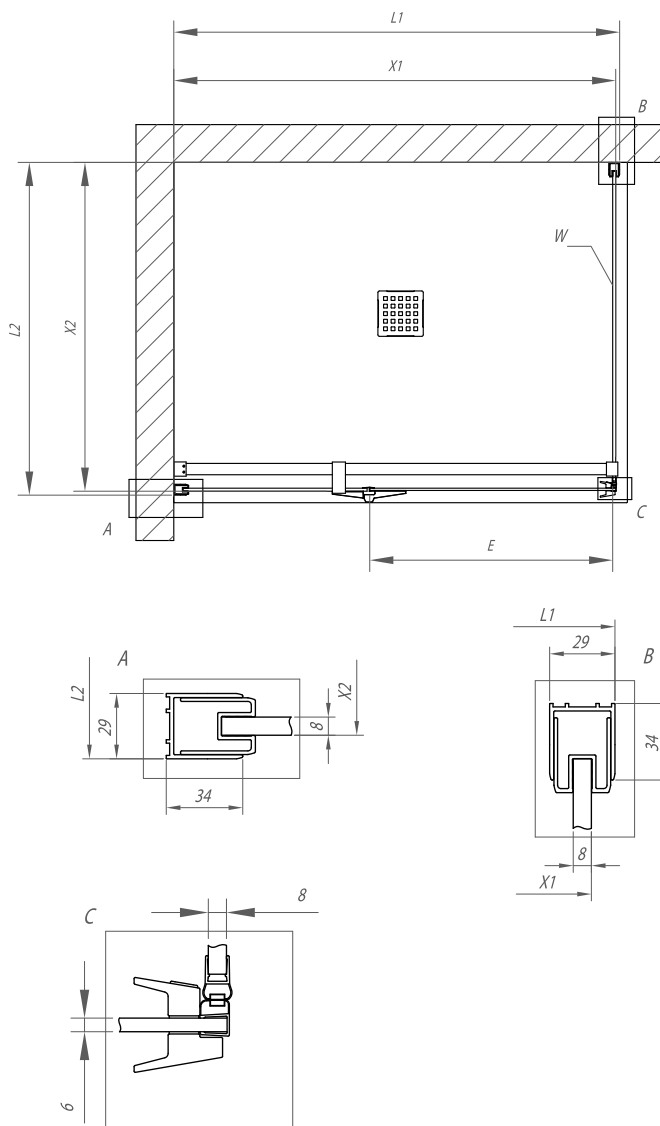

Ballo, Tello, Lavolta, Lerock zero, Ramona tray, Limbo, Re-walk, Acro, Pandora Tray, Canary, Serra, Drop, Flamenco, Funky, Evelin Tray Q.

Polaris			L1	L2	X1	X2		E	
D 140			1380 - 1390		1370 - 1380		2000	610	
D 120			1180 - 1190		1170 - 1180		2000	610	
D 100			980 - 990		970 - 980		2000	610	
D 90			880 - 890		870 - 880		2000	510	
D 80			780 - 790		770 - 780		2000	450	
W 100				980 - 990		970 - 980	2000		
W 90				880 - 890		870 - 880	2000		
W 80				780 - 790		770 - 780	2000		

Polaris D 140, 120, 100, 90, 80 + W 100, 90, 80



# Polaris R 100, 90

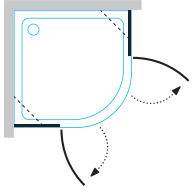

## R 100, 90

- Semi-circular shower enclosure with double-wing doors.
- Halbrunde duschkabine mit zweiflügelige eingehängte Türen.
- Ризогнутое душевая кабина с двумя подвижными дверями на шарнирах.
- Negyedköríves zuhanykabin két ajtóval, zsanérokkaal.

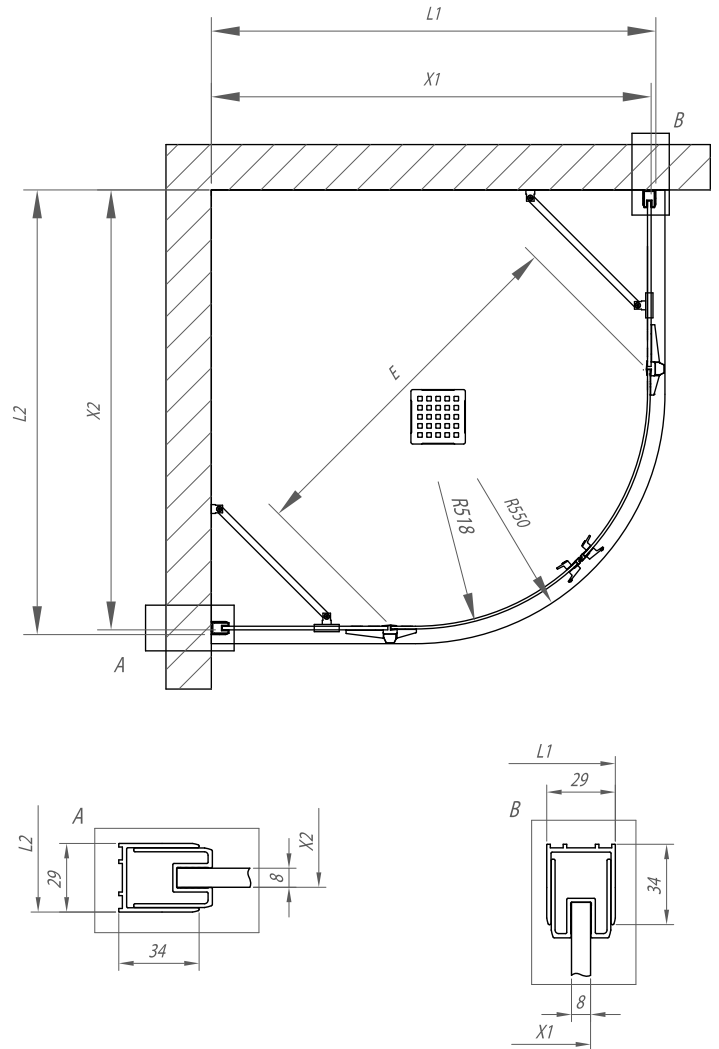

Polaris R 100, 90



Lavolta R, Moonwalk R, Macarena, Drop R, Dixie, Evelin Tray R, Ontex.

Polaris			L1	L2	X1	X2			E	
R 100			980 - 990	980 - 990	970 - 980	970 - 980	550	2000	775	
R 90			880 - 890	880 - 890	870 - 880	870 - 880	550	2000	775	



Polaris fold

# POLARIS FOLD

 <b>8/6 mm</b>	<p><b>8/6 mm transparent tempered glass</b>                  8/6 mm transparentes gehärtetes Glas                  8/6 мм прозрачное закаленное стекло                  8/6 mm átlátszó edzett üveg</p>	 
 <b>2000 mm</b>	<p><b>Silver Brill Studs (high gloss-polished silver galvanised coating)</b>                  Silber Brill Profile (hochglanzpolierte silberne galvanische Beschichtung)                  Серебристые профили бриллиант (серебряное гальваническое покрытие высококачественной полировки)                  Ezüst Brill profilok (magas fényezésű ezüst galvanizált burkolat)</p>	 
 <b>2000 mm</b>	<p><b>BLACK profiles, powder coating</b>                  BLACK (schwarze) Profile, staublackiert                  BLACK (черные) профили, порошковое покрытие лаком                  BLACK (fekete) profilok, porlakkozás</p>	 
 	<p><b>magnetic edge closure</b>                  Magnetprofil-Verschluss                  закрытие с магнитным профилем                  zárás mágneses profilal</p>	
 	<p><b>turning section with lifting function</b>                  Drehprofil mit Hubfunktion                  поворотный профиль с функцией подъема                  emelő funkció forgásprofil</p>	
 	<p><b>hinges with lifting function</b>                  Scharniere mit Hubfunktion                  петли с функцией подъема                  zsanérok emelő funkcióval</p>	
 	<p><b>support for the stability of the shower enclosure</b>                  Stütze für die Stabilität der Duschkabine                  опора для устойчивости душевой кабины                  támaszték a zuhanyfülke stabilizálásához</p>	
 	<p><b>an additional aluminium edge on the shower tray prevents overflow</b>                  ein zusätzliches Alu-Profil auf der Duschwanne verhindert das Auslaufen von Wasser                  дополнительные алюминиевые профили на поддоне, предотвращающие утечку воды                  kiegészítő alumínium profil, amely megakadályozza a víz kifolyását</p>	
 <b>kolpa Clean Coat</b>	<p><b>Clean coat, protective coating</b>                  Clean coat, Schutzbeschichtung                  Clean coat защитное покрытие                  Clean coat, védőbevonat</p>	

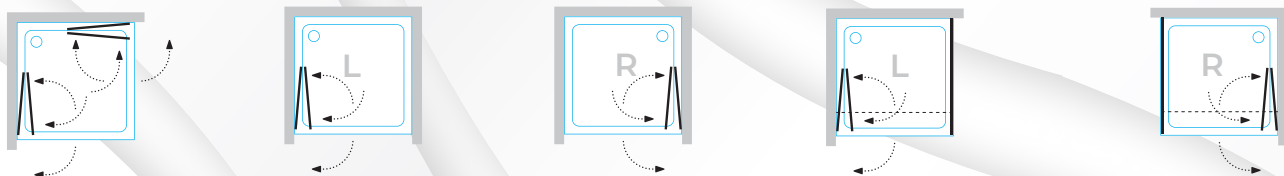

# Polaris fold Q 100, 90, 80

148

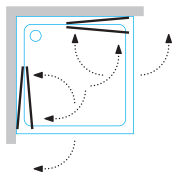

## Q 100, 90, 80

- Corner shower cabin, can fold inwards or outwards.
- Eckeinstieg 2-teilig mit Pendel - Falttüren.
- Угловая душевая кабина открывается внутрь или наружу.
- Sarok zuhanykabin, összecusukható a belső vagy a külső oldal irányában.

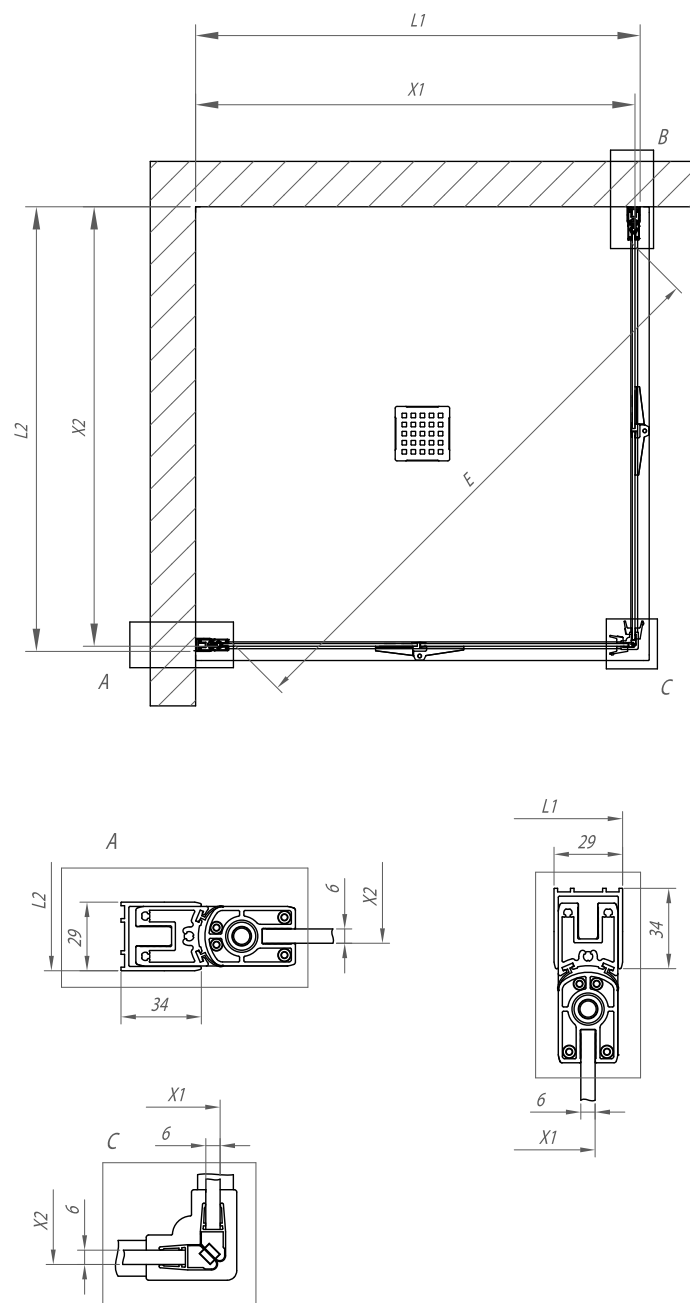
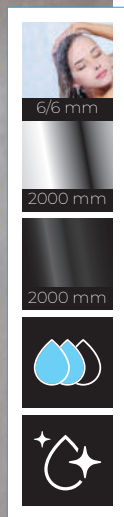

Polaris fold Q 100, 90, 80

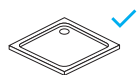

Ballo, Tello, Lavolta, Lerock zero, Ramona tray, Limbo, Re-walk, Acro, Pandora Tray, Canary, Serra, Drop, Flamenco, Evelin Tray Q.

Polaris fold			L1	L2	X1	X2		E	
Q 100			980 - 990	980 - 990	969 - 979	969 - 979	2000	1250	
Q 90			880 - 890	880 - 890	869 - 879	869 - 879	2000	1100	
Q 80			780 - 790	780 - 790	769 - 779	769 - 779	2000	970	

# Polaris fold N 100, 90, 80



## N 100, 90, 80

- Individual shower door, can fold inwards or outwards. Installed in a recess.
- Pendel - Falttüre in Nische. Möglichkeit der Montage in die Nische.
- Душевые дверцы, открываются внутрь или наружу. Возможность установки в нише.
- Önálló zuhanyajtó, összecsukszható a belső vagy a külső oldal irányában. Lehetséges a fülkébe szerelés.

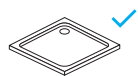
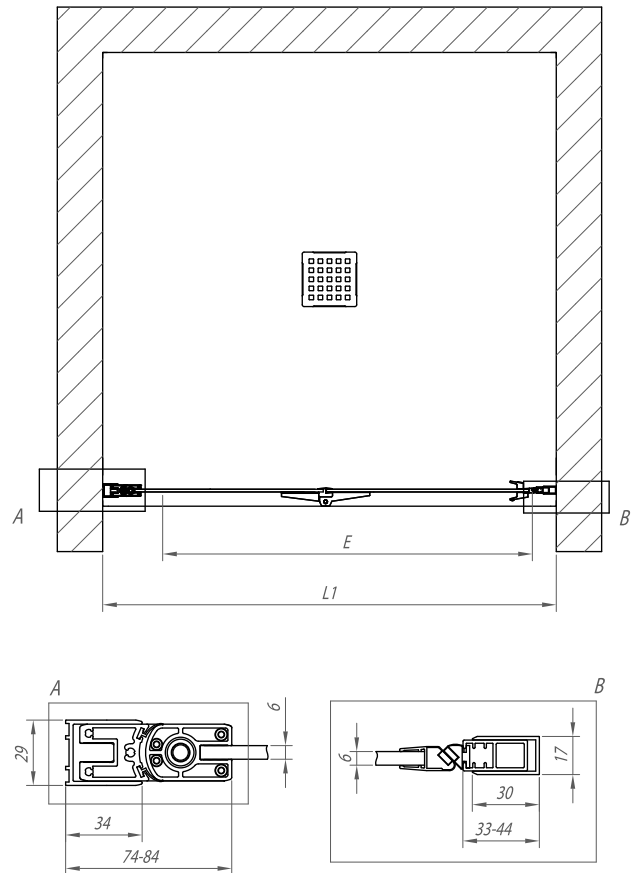

Ballo, Tello, Lavolta, Lerock zero, Ramona tray, Limbo, Re-walk, Acro, Pandora Tray, Canary, Serra, Drop, Flamenco, Evelin Tray Q.

Polaris fold			L1	L2	X1	X2		E	
N 100			980 - 1000				2000	815	
N 90			880 - 900				2000	715	
N 80			780 - 800				2000	615	

# Polaris fold D 100, 90, 80 + W 100, 90, 80

150



## D 100, 90, 80 + W 100, 90, 80

- Shower enclosure - door and wall, can fold inwards or outwards.
- Gleittür 2-teilig mit Festfeld + Seitenwand.
- Душевая кабина - дверь и стенка, открываются внутрь или наружу.
- Zuhanykabin - ajtó és fal, összecsukszható a belső vagy a külső oldal irányában.

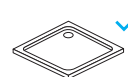
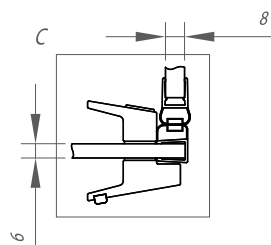
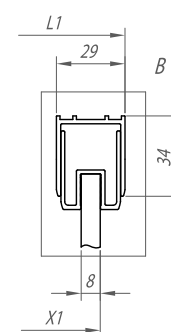
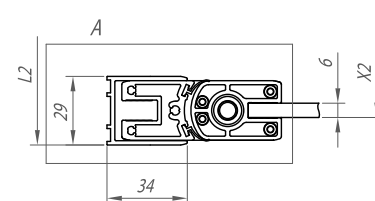
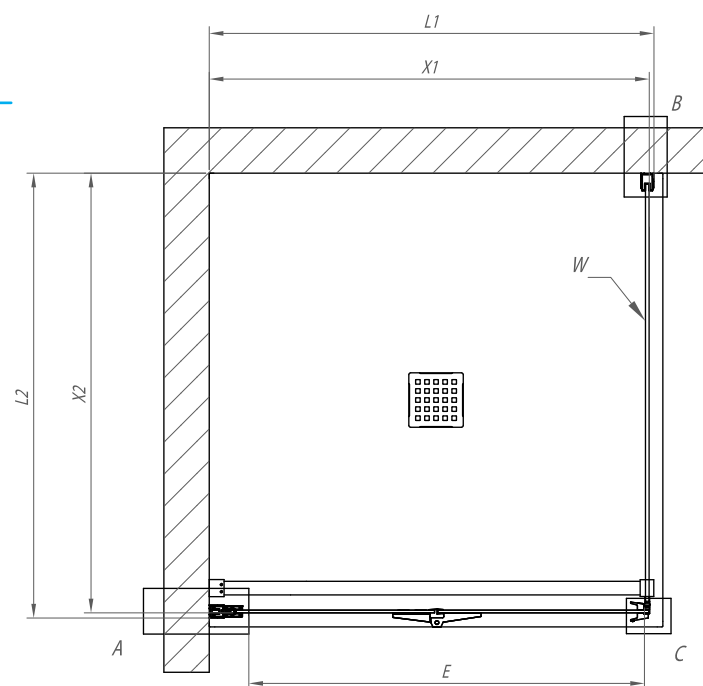

- ✓ Tello, Lavolta, Lerock zero, Re-walk, Acro, Pandora Tray, Canary, Serra, Drop, Flamenco, Funky, Evelin Tray Q.

Polaris fold			L1	L2	X1	X2		E	
W 100			980 - 990	980 - 990		969 - 979	2000		
W 90			880 - 890	880 - 890		869 - 879	2000		
W 80			780 - 790	780 - 790		769 - 779	2000		
D 100			980 - 990		970 - 980		2000	840	
D 90			880 - 890		870 - 880		2000	740	
D 80			780 - 790		770 - 780		2000	640	



















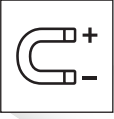

Andromeda

# ANDROMEDA



 <b>8/6 mm</b>	<p><b>8/6 mm transparent tempered glass</b>        8/6 mm transparentes gehärtetes Glas        8/6 мм прозрачное закаленное стекло        8/6 mm átlátszó edzett üveg</p>	 
 <b>2000 mm</b>	<p><b>Silver Brill Studs (high gloss-polished silver galvanised coating)</b>        Silver Brill profili (visokopolirana srebrna galvanska prevlaka)        Серебристые профили бриллиант (серебряное гальваническое покрытие высококачественной полировки)        Ezüst Brill profilok (magas fényezésű ezüst galvanizált burkolat)</p>	 
 <b>2000 mm</b>	<p><b>BLACK profiles, powder coating</b>        BLACK (schwarze) Profile, staublackiert        BLACK (черные) профили, порошковое покрытие лаком        BLACK (fekete) profilok, porlakkozás</p>	 
 	<p><b>magnetic edge closure</b>        Magnetprofil-Verschluss        закрытие с магнитным профилем        zárás mágneses profillal</p>	
 	<p><b>turning section with lifting function</b>        Drehprofil mit Hubfunktion        поворотный профиль с функцией подъема        emelő funkció forgásprofil</p>	
 	<p><b>support for the stability of the shower enclosure</b>        Stütze für die Stabilität der Duschkabine        опора для устойчивости душевой кабины        támaszték a zuhanyfülke stabilizálásához</p>	
 	<p><b>an additional aluminium edge on the shower tray prevents overflow</b>        ein zusätzliches Alu-Profil auf der Duschwanne verhindert das Auslaufen von Wasser        дополнительные алюминиевые профили на поддоне, предотвращающие утечку воды        kiegészítő alumínium profil, amely megakadályozza a víz kifolyását</p>	
 	<p><b>Clean coat, protective coating</b>        Clean coat, Schutzbeschichtung        Clean coat защитное покрытие        Clean coat, védőbevonat</p>	

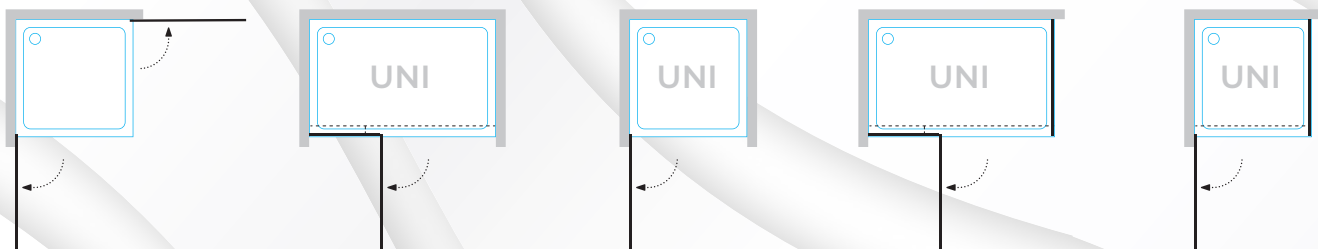

# Andromeda Q 100, 90, 80

154

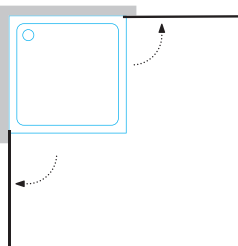

## Q 100, 90, 80

- Corner shower enclosure with double-wing doors.
- Eckduschkabine mit zweiflügelige eingehängte Türen.
- Угловая душевая кабина с двумя подвижными дверями на шарнирах.
- Négyszögletes zuhanykabin két egyenes ajtóval, zsanérokkal.

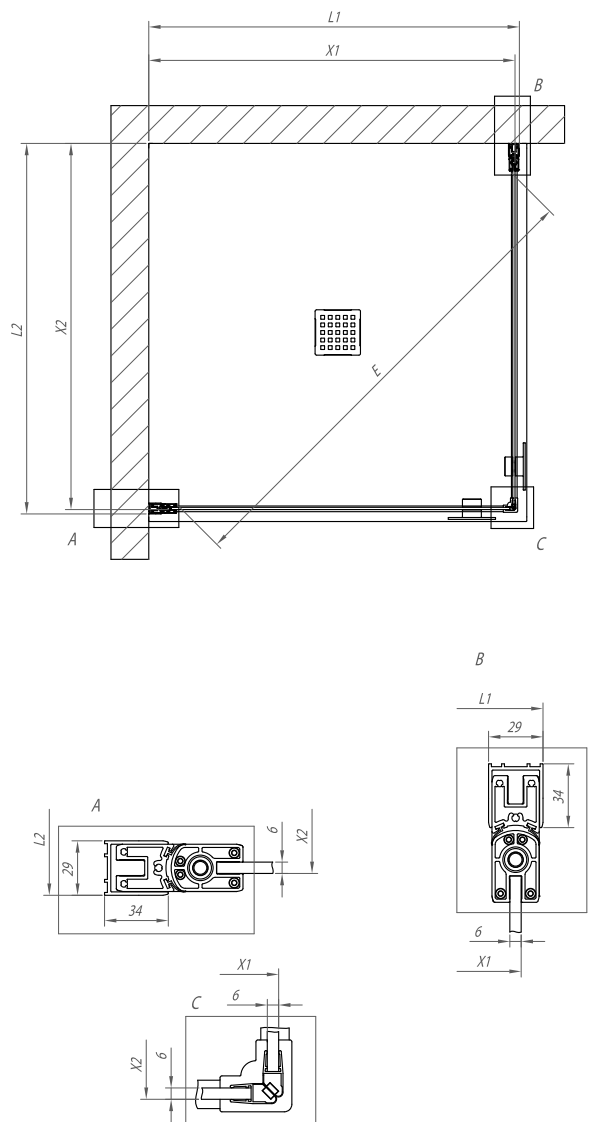

Andromeda Q 100, 90, 80



✓ Tello, Lavolta, Lerock zero, Pandora Tray, Canary, Serra, Drop, Flamenco, Evelin Tray Q, Trin.

Andromeda			L1	L2	X1	X2		E	
Q 100			980 - 990	980 - 990	969 - 979	969 - 979	2000	1250	
Q 90			880 - 890	880 - 890	869 - 879	869 - 879	2000	1100	
Q 80			780 - 790	780 - 790	769 - 779	769 - 779	2000	970	

# Andromeda N 160, 140, 120

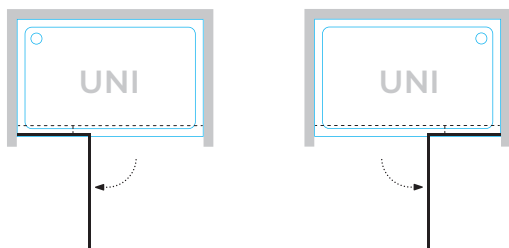

## N 160, 140, 120

- Self-supporting shower door, single-side opening.
- Gleittür 2-teilig mit Festfeld in Nische
- Самостоятельные двери для душевой кабины, односторчатое открывание
- Önálló zuhanyajtó, egyirányú nyitással.

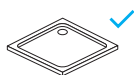
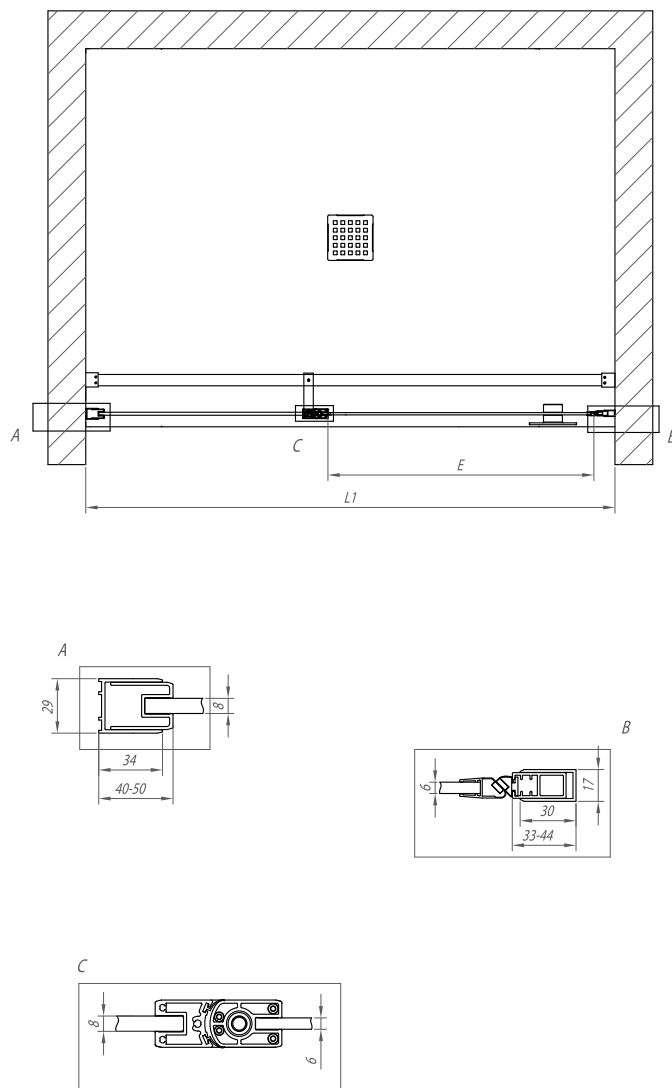

Ballo, Tello, Lavolta, Lerock zero, Ramona Tray, Limbo, Re-walk, Acro, Pandora Tray, Canary, Serra, Drop, Flamenco, Evelin Tray Q.

Andromeda			L1	L2	X1	X2		E	
N 160			1580 - 1600				2000	713	
N 140			1380 - 1400				2000	713	
N 120			1180 - 1200				2000	713	

# Andromeda N 100, 90, 80

156



## N 100, 90, 80

- Self-supporting shower door, single-side opening.
- Gleittür 2-teilig mit Festfeld in Nische
- Самостоятельные двери для душевой кабины, односторчатое открывание
- Önálló zuhanyajtó, egyirányú nyitással.



Andromeda D 100, 90, 80

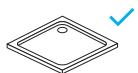
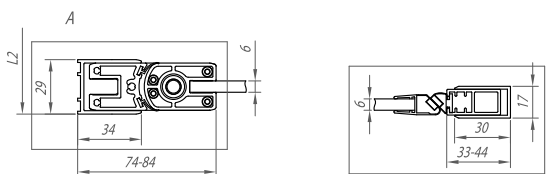
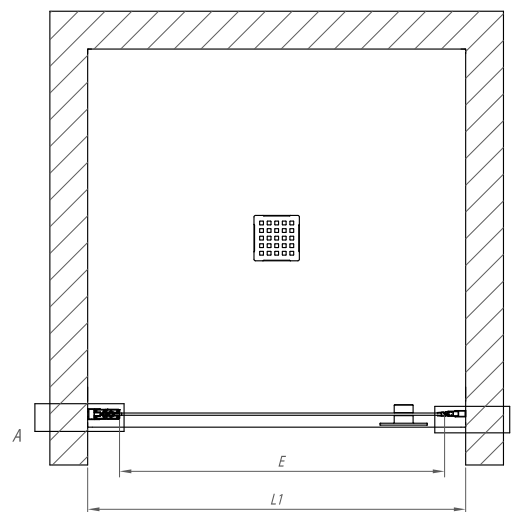

Ballo, Tello, Lavolta, Lerock zero, Ramona tray, Limbo, Re-walk, Acro, Pandora Tray, Canary, Serra, Drop, Funky, Flamenco, Evelin Tray Q.

Andromeda			L1	L2	X1	X2		E	
N 100			980 - 1000				2000	870	
N 90			880 - 900				2000	770	
N 80			780 - 800				2000	670	

# Andromeda D 160, 140, 120 + W 100, 90, 80

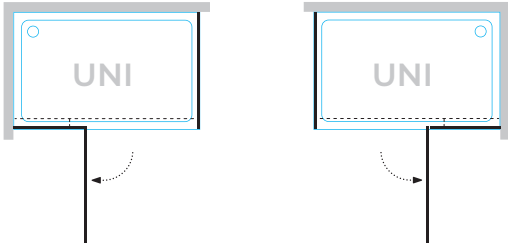

## D 160, 140, 120 + W 100, 90, 80

- Shower door with shower wall.
- Schwingtür mit Festfeld + Seitenwand.
- Душевые шторы с душевой панелью.
- Zuhanyajtó zuhanyfallal.

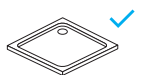
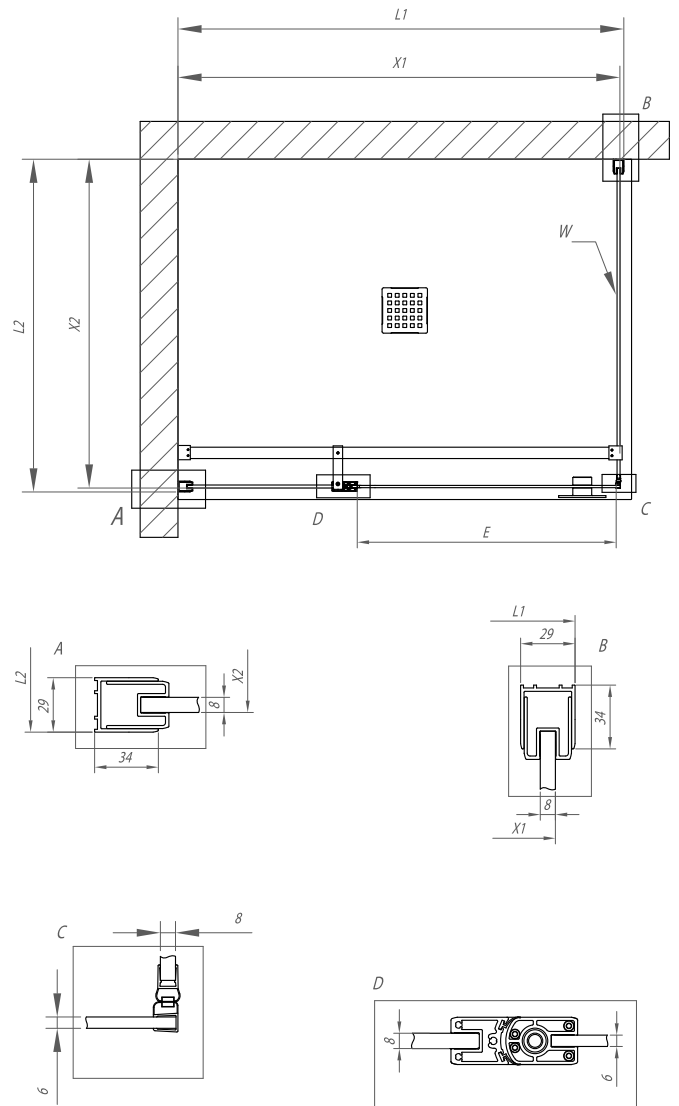

Ballo, Tello, Lavolta, Lerock zero, Ramona tray, Limbo, Re-walk, Acro, Pandora Tray, Canary, Serra, Drop, Funky, Flamenco, Evelin Tray Q.

Andromeda			L1	L2	X1	X2		E	
D 160			1580 - 1590		1570 - 1580		2000	695	
D 140			1380 - 1390		1370 - 1380		2000	695	
D 120			1180 - 1190		1170 - 1180		2000	695	
W 100				980 - 990		970 - 980	2000		
W 90				880 - 890		870 - 880	2000		
W 80				780 - 790		770 - 780	2000		

# Andromeda D 100, 90, 80 + W 100, 90, 80

158

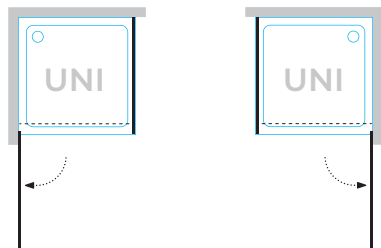

## D 100, 90, 80 + W 100, 90, 80

- Shower door with shower wall.
- Schwingtür mit Festfeld + Seitenwand.
- Душевые шторки с душевой панелью.
- Zuhanyajtó zuhanyfallal.

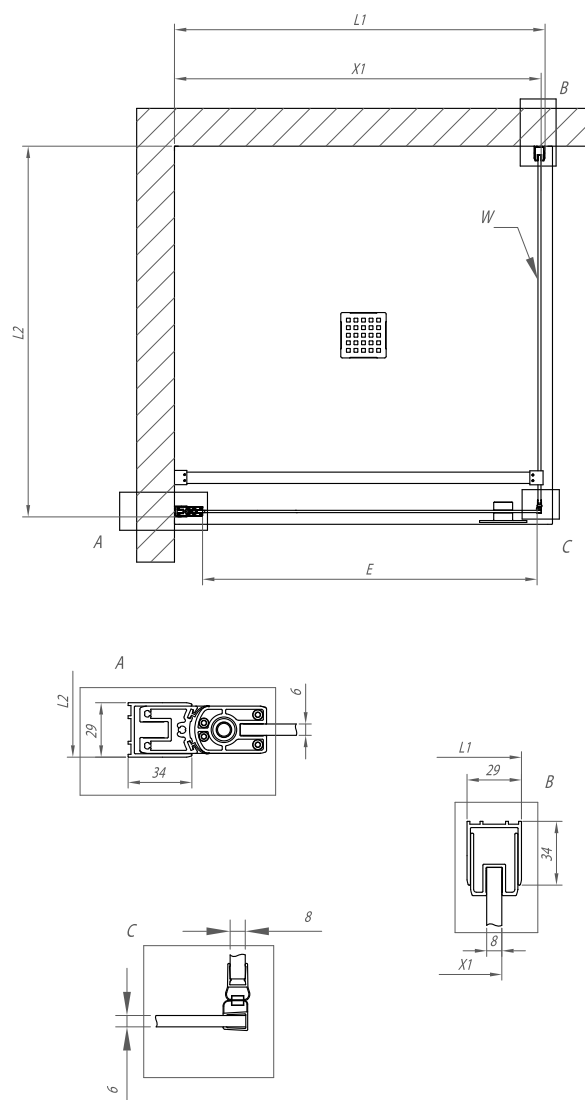

Andromeda D 100, 90, 80 + W 100, 90, 80

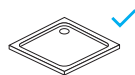

Tello, Lavolta, Lerock zero, Re-walk, Acro, Pandora Tray, Canary, Serra, Drop, Flamenco, Funky, Evelin Tray Q.

Andromeda			L1	L2	X1	X2		E	
D 100			980 - 990		970 - 980		2000	895	
D 90			880 - 890		870 - 880		2000	795	
D 80			780 - 790		770 - 780		2000	695	
W 100				980 - 990		970 - 980	2000		
W 90				880 - 890		870 - 880	2000		
W 80				780 - 790		770 - 780	2000		



















160



Atlas

# ATLAS



 <p>6 mm</p>	<p><b>6 mm transparent tempered glass</b>          6 mm transparentes gehärtetes Glas          6 мм прозрачное закаленное стекло          6 mm átlátszó edzett üveg</p>	 
 <p>6 mm</p>	<p><b>6 mm Frost tempered glass</b>          6 mm Frost gehärtetes Glas          6 мм Фрост закаленное стекло          6 mm Frost edzett üveg</p>	 
 <p>2000 mm</p>	<p><b>Silver Brill Studs (high gloss-polished silver galvanised coating)</b>          Silver Brill profili (visokopolirana srebrna galvaniska prevlaka)          Серебристые профили бриллиант (серебряное гальваническое покрытие высококачественной полировки)          Ezüst Brill profilok (magas fényezésű ezüst galvanizált burkolat)</p>	  <p>SBR</p>
	<p><b>magnetic edge closure</b>          Magnetprofil-Verschluss          закрытие с магнитным профилем          zárás mágneses profillal</p>	
	<p><b>chromed hinges with lift function</b>          Chromscharniere mit Hebefunktion          хромированные петли с функцией подъема          krómozott pántok emelőfunkcióval</p>	
	<p><b>additional brackets</b>          zusätzliche Träger          дополнительные носители          kiegészítő hordozóelemek</p>	
	<p><b>an additional aluminium edge on the shower tray prevents overflow</b>          ein zusätzliches Alu-Profil auf der Duschwanne verhindert das Auslaufen von Wasser          дополнительные алюминиевые профили на поддоне, предотвращающие утечку воды          kiegészítő alumínium profil, amely megakadályozza a víz kifolyását</p>	

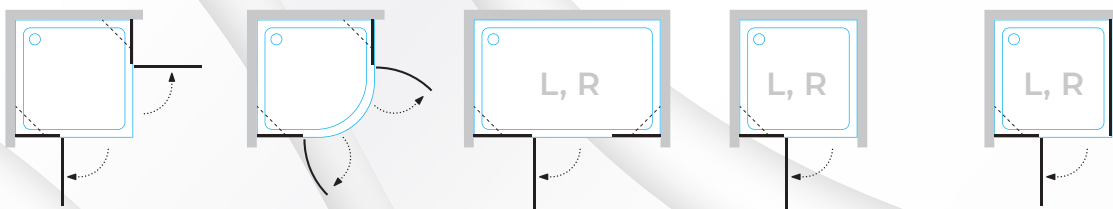

# Atlas Tkk 100, 90

162

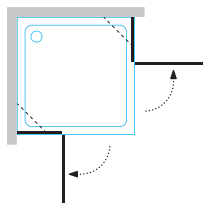

## TKK 100, 90

- Corner shower enclosure with double-wing doors.
- Eckduschkabine mit zweiflügelige eingehängte Türen.
- Угловая душевая кабина с двумя подвижными дверями на шарнирах.
- Négyszögletes zuhanykabin két egyenes ajtóval, zsanérokkal.

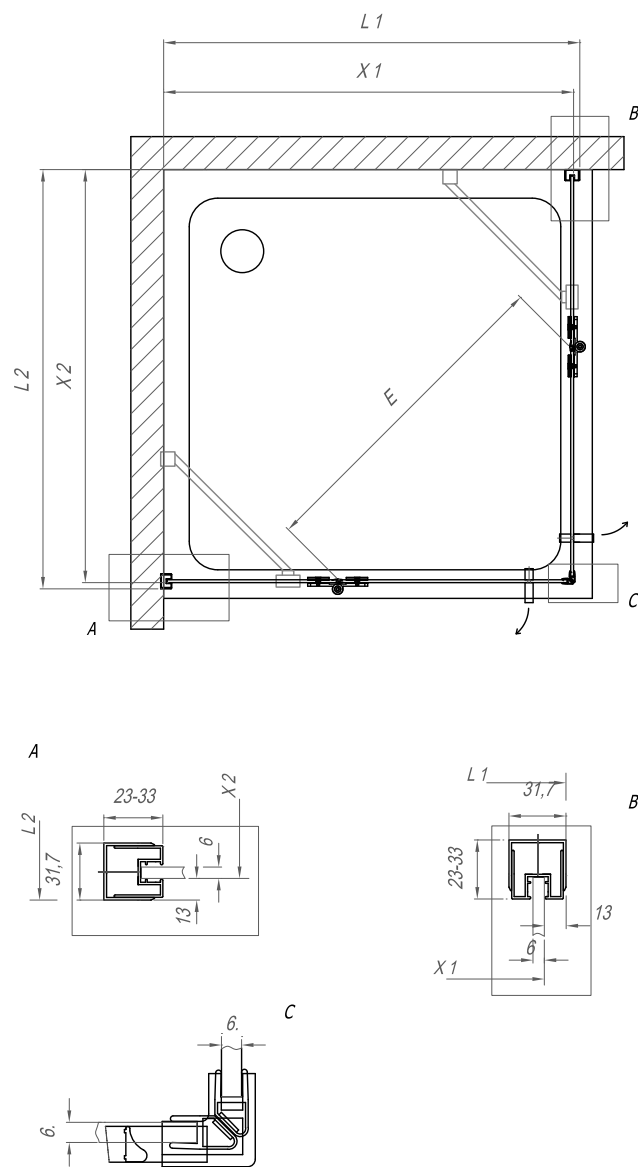

Atlas Tkk 100, 90

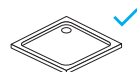

Tello, Lavolta, Lerock zero, Pandora Tray, Canary, Serra, Drop, Flamenco, Evelin Tray Q, Trin.

Atlas			L1	L2	X1	X2		E	
TKK 100 (FROST)			980 - 990	980 - 990	967 - 977	967 - 977	2000	685	
TKK 90 (FROST)			880 - 890	880 - 890	867 - 877	867 - 877	2000	685	

# Atlas TKP 100, 90

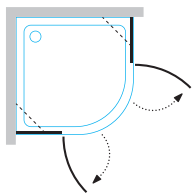

## TKP 100, 90

- Semi-circular shower enclosure with double-wing doors.
- Halbrunde duschkabine mit zweiflügelige eingehängte Türen.
- Ризогнутое душевая кабина с двумя подвижными дверями на шарнирах.
- Negyedköríves zuhanykabin két ajtóval, zsanérokkal.

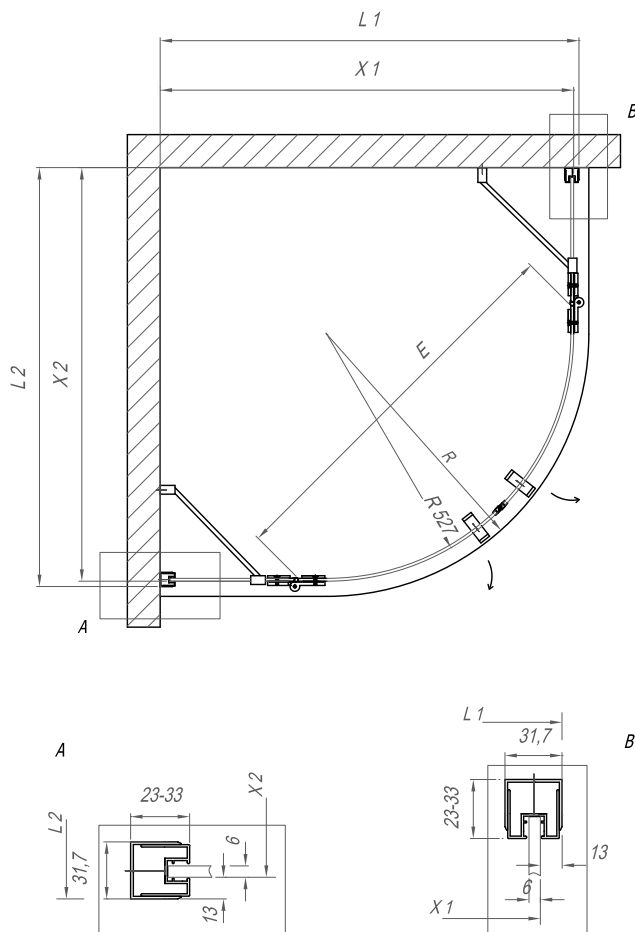

Lavolta R, Moonwalk R, Macarena, Drop R, Dixie, Evelin Tray R, Ontex.

Atlas			L1	L2	X1	X2			E	
TKP 100 (FROST)			980 - 990	980 - 990	967 - 977	967 - 977	550	2000	720	
TKP 90 (FROST)			880 - 890	880 - 890	867 - 877	867 - 877	550	2000	720	

# Atlas TV/S 120/K - L, R

164

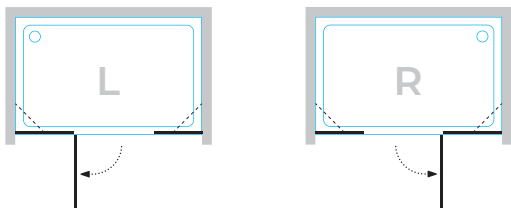

## TV/S 120/K - L, R

- Self-supporting shower door. Installed in a recess.
- Eigenständige Duschtür. Möglichkeit der Montage in die Nische.
- Самостоятельные дверцы для душа. Возможность установки в нише.
- Önálló zuhanyajtó. Lehetséges a fülkébe szerelés.



6 mm

2000 mm

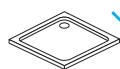
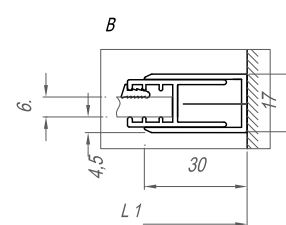
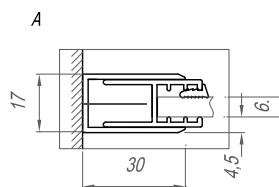
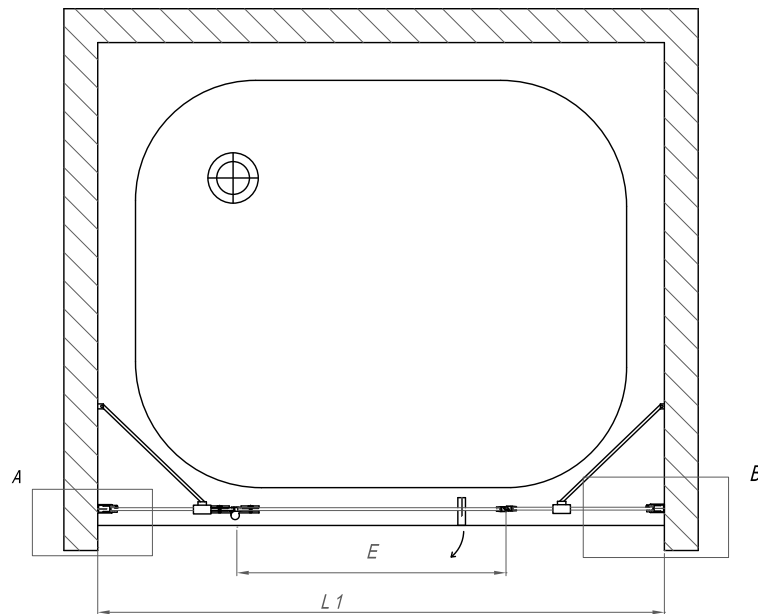

✓ Ballo, Tello, Lavolta, Lerock zero, Ramona tray, Limbo, Re-walk, Acro, Pandora Tray, Canary, Serra, Drop, Flamenco, Funky, Evelin Tray Q.

Atlas TV/S 120/K-L, R

# Atlas TV/S 100, 90/K - L, R

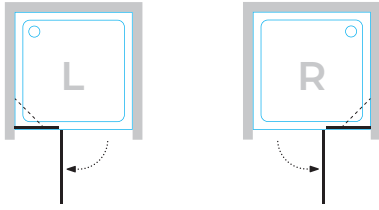

## TV/S 100, 90 - L, R

- Self-supporting shower door. Installed in a recess.
- Eigenständige Duschtür. Möglichkeit der Montage in die Nische.
- Самостоятельные дверцы для душа. Возможность установки в нише.
- Önálló zuhanyajtó. Lehetséges a fülkébe szerelés.

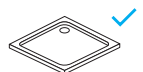
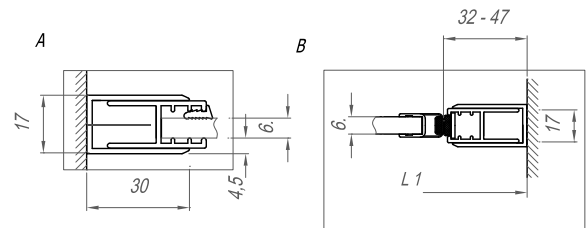
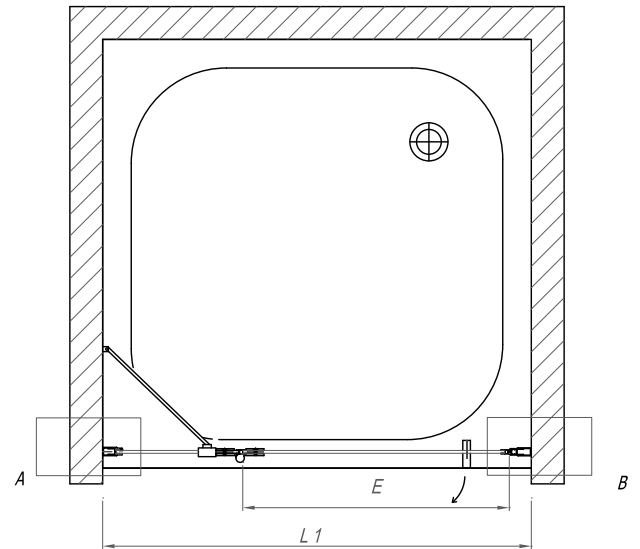

Tello, Lavolta, Lerock zero, Ramona tray, Limbo, Re-walk, Acro, Pandora Tray, Canary, Serra, Drop, Flamenco, Funky, Evelin Tray Q, Trin.

Atlas			L1	L2	X1	X2		E	
TV/S 100/K -L, R			980 - 1000				2000	530	
TV/S 90/K -L, R			880 - 900				2000	530	

# Atlas TV/S 120, 100, 90/K - L, R + TSv 90, 80/K

166

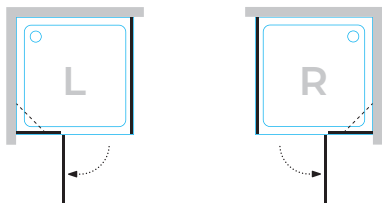

## TV/S 100, 90/K - L, R + TSv 90, 80/K

- Shower door with shower wall.
- Schwingtür mit Festfeld + Seitenwand.
- Душевые шторки с душевой панелью.
- Zuhanyajtó zuhanyfallal.

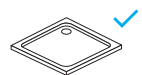
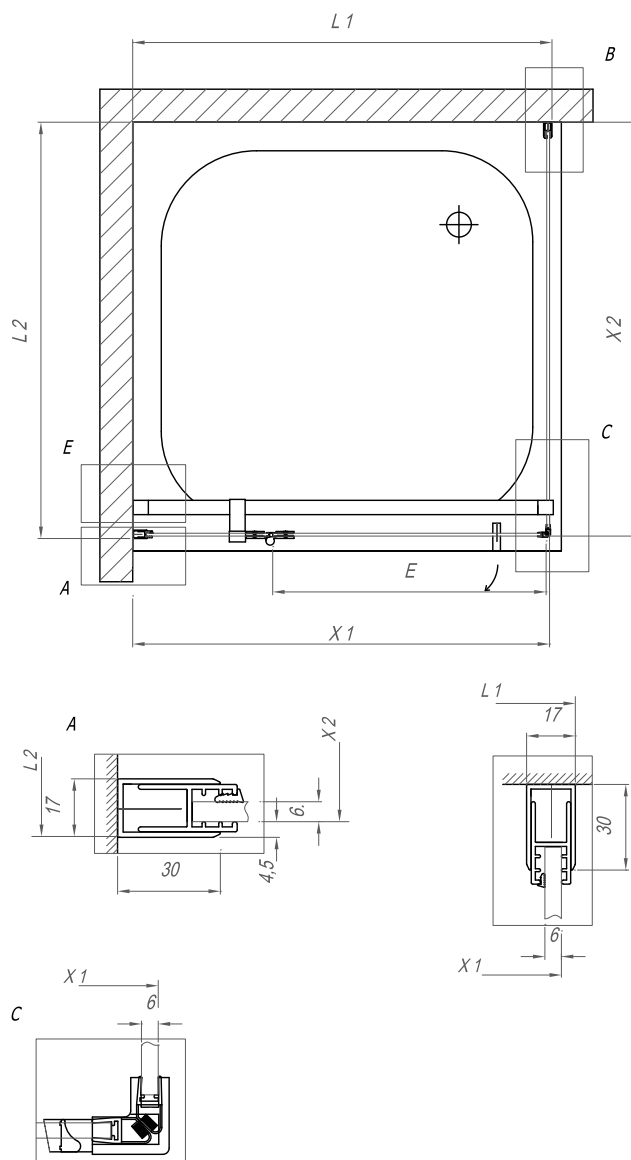

Tello, Lavolta, Lerock zero, Ramona tray, Limbo, Re-walk, Acro, Pandora Tray, Canary, Serra, Drop, Flamenco, Funky, Evelin Tray Q, Trin.













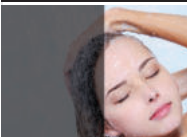

Atlas			L1	L2	X1	X2		E	
TV 120/K -L, R			1180 - 1190		1175 - 1185		2000	570	
TV 100/K -L, R			980 - 990		975 - 985		2000	530	
TV 90/K -L, R			880 - 900		875 - 885		2000	530	
TSv 90/K -L, R				880 - 890		875 - 885	2000		
TSv 80/K -L, R				780 - 790		775 - 785	2000		



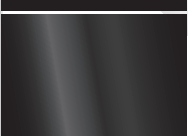

# CALYPSO

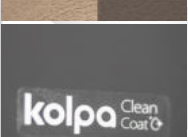

	<p><b>8 mm transparent tempered glass</b>                  8 mm transparentes gehärtetes Glas                  8 мм прозрачное закаленное стекло                  8 mm átlátszó edzett üveg</p>	 
	<p><b>8 mm graphite tempered glass</b>                  8 mm graphite gehärtetes Glas                  8 мм графит закаленное стекло                  8 mm graphite öntött üveg</p>	 
	<p><b>Silver Brill Studs (high gloss-polished silver galvanised coating)</b>                  Silver Brill profili (visokopolirana srebrna galvaniska prevlaka)                  Серебристые профили бриллиант (серебряное гальваническое покрытие высококачественной полировки)                  Ezüst Brill profilok (magas fényezésű ezüst galvanizált burkolat)</p>	 
	<p><b>BLACK profiles, powder coating</b>                  BLACK (schwarze) Profile, staublackiert                  BLACK (черные) профили, порошковое покрытие лаком                  BLACK (fekete) profilok, porlakkozás</p>	 
	<p><b>support for the stability of the shower enclosure</b>                  Stütze für die Stabilität der Duschkabine                  опора для устойчивости душевой кабины                  támaszték a zuhanyfülke stabilizálásához</p>	
	<p><b>Clean coat, protective coating</b>                  Clean coat, Schutzbeschichtung                  Clean coat защитное покрытие                  Clean coat, védőbevonat</p>	

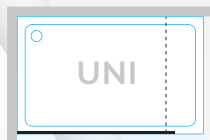
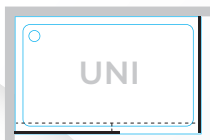

# Calypso WIN 160, 140

170

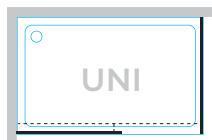

## WIN 160, 140

- Shower cabin that can either be installed on a shower tray or directly on the floor (no shower tray required).
- Duschkabine, auf Duschwanne oder direkt auf den Boden aufstellbar (keine Duschwanne erforderlich).
- Душевая кабина с возможностью установки на душевой поддон или прямо на пол (без душевого поддона).
- Zuhanyfülké, illetve közvetlen a padlóra (zuhanytálca nélkül) állítható zuhanykabin.

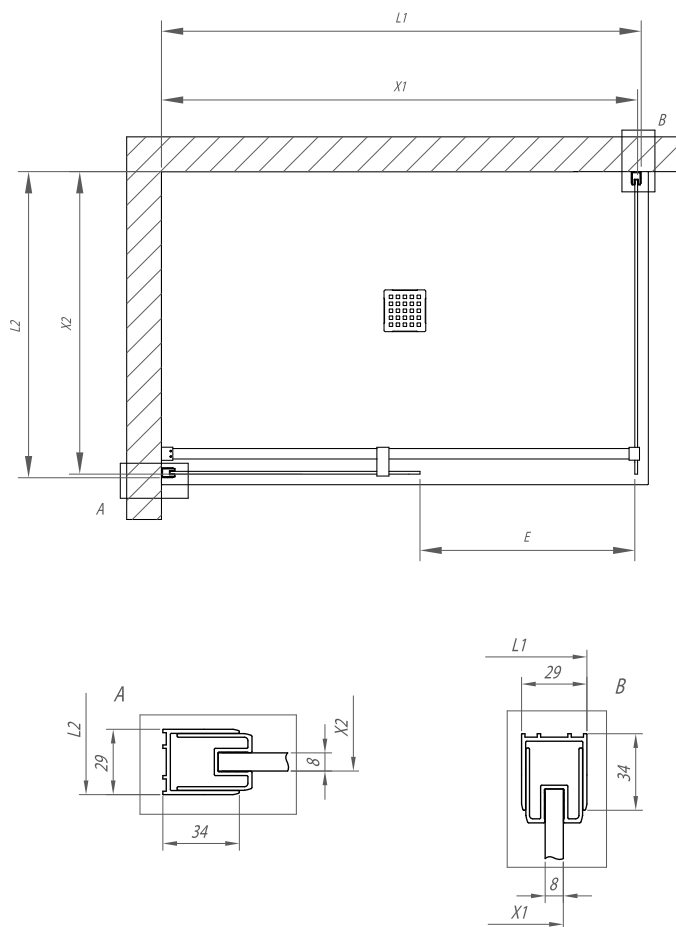

Calypso WIN 160, 140

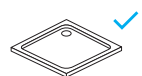

Ballo, Tello, Lavolta, Lerock zero, Ramona tray, Limbo, Re-walk, Acro, Pandora Tray, Canary, Serra, Drop, Flamenco, Evelin Tray Q.

Calypso			L1	L2	X1	X2		E	
WIN 160x100			1580 - 1590	980 - 990	1570 - 1580	970 - 980	2000	617	
WIN 160x90			1580 - 1590	880 - 890	1570 - 1580	870 - 880	2000	617	
WIN 160x80			1580 - 1590	780 - 790	1570 - 1580	770 - 780	2000	617	
WIN 140x100			1380 - 1390	980 - 990	1370 - 1380	970 - 980	2000	617	
WIN 140x90			1380 - 1390	880 - 890	1370 - 1380	870 - 880	2000	617	
WIN 140x80			1380 - 1390	780 - 790	1370 - 1380	770 - 780	2000	617	

# Calypso WO 140, 120, 100

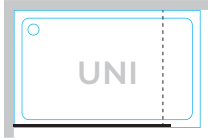

## WO 140, 120, 100

- Shower wall that can either be installed on a shower tray or directly on the floor (no shower tray required).
- Duschwand, auf Duschwanne oder direkt auf den Boden aufstellbar (keine Duschwanne erforderlich).
- Душевая стена с возможностью установки на душевой поддон или прямо на пол (без душевого поддона).
- Zuhanytálcára, illetve közvetlen a padlóra (zuhanytálca nélkül) állítható OPEN zuhanyfal.

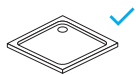
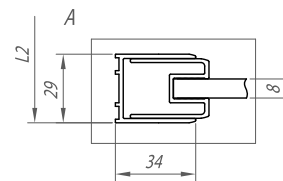
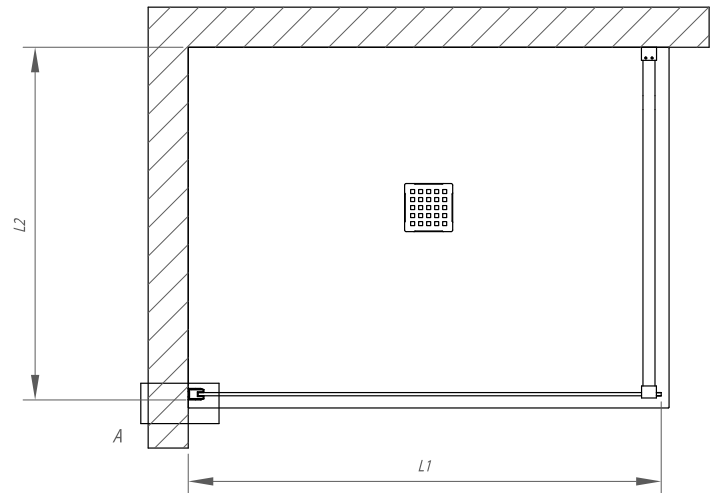

Ballo, Tello, Lavolta, Lerock zero, Ramona tray, Limbo, Re-walk, Acro, Pandora Tray, Canary, Serra, Drop, Flamenco, Evelin Tray Q.













Calypso			L1	L2	X1	X2		E	
WO 140			1380 - 1390	max 1200			2000		
WO 120			1180 - 1190	max 1200			2000		
WO 100			980 - 990	max 1200			2000		

172

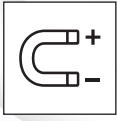

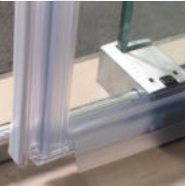
Virgo UNI

# VIRGO UNI

 <b>8 mm</b>	<p><b>8 mm transparent tempered glass</b>        8 mm transparentes gehärtetes Glas        8 мм прозрачное закаленное стекло        8 mm átlátszó edzett üveg</p>	 
 <b>2000 mm</b>	<p><b>Silver Brill Studs (high gloss-polished silver galvanised coating)</b>        Silver Brill profili (visokopolirana srebrna galvaniska prevlaka)        Серебристые профили бриллиант (серебряное гальваническое покрытие высококачественной полировки)        Ezüst Brill profilok (magas fényezésű ezüst galvanizált burkolat)</p>	 
 <b>2000 mm</b>	<p><b>BLACK profiles, powder coating</b>        BLACK (schwarze) Profile, staublackiert        BLACK (черные) профили, порошковое покрытие лаком        BLACK (fekete) profilok, porlakkozás</p>	 
	<p><b>magnetic edge closure</b>        Magnetprofil-Verschluss        закрытие с магнитным профилем        zárás mágneses profillal</p>	
	<p><b>door leaf on solid ball bearings</b>        Türflügel auf massiven Kugellagern        ajtószárny masszív golyócsapágyakon        дверное полотно на шарикоподшипниках</p>	
	<p><b>mounting plug allows easier cleaning</b>        der Demontagezapfen ermöglicht eine einfache Reinigung        нимающася пробка позволяет легкую чистку        a kiszerezési dugó a könnyebb tisztítást teszi lehetővé</p>	
	<p><b>towel holder</b>        Handtuchhalter        держатель для полотенец        törülközőtartó</p>	
	<p><b>an additional aluminium edge on the shower tray prevents overflow</b>        ein zusätzliches Alu-Profil auf der Duschwanne verhindert das Auslaufen von Wasser        дополнительные алюминиевые профили на поддоне, предотвращающие утечку воды        kiegészítő alumínium profil, amely megakadályozza a víz kifolyását</p>	
	<p><b>Clean coat, protective coating</b>        Clean coat, Schutzbeschichtung        Clean coat защитное покрытие        Clean coat, védőbevonat</p>	

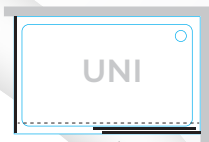

# Virgo UNI TK 160, 140, 120

174

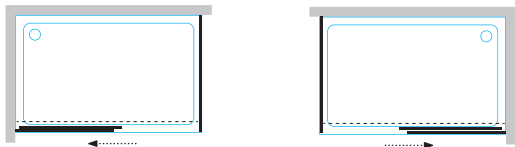

## TK 160, 140, 120

- Shower enclosure - door and wall, left or right-side opening.
- Gleittür 2-teilig mit Festfeld + Seitenwand
- Душевая кабина - дверь и стенка, одностворчатое открывание вправо или влево
- Zuhanykabin - ajtó és fal, bal vagy jobb egyirányú nyitással.

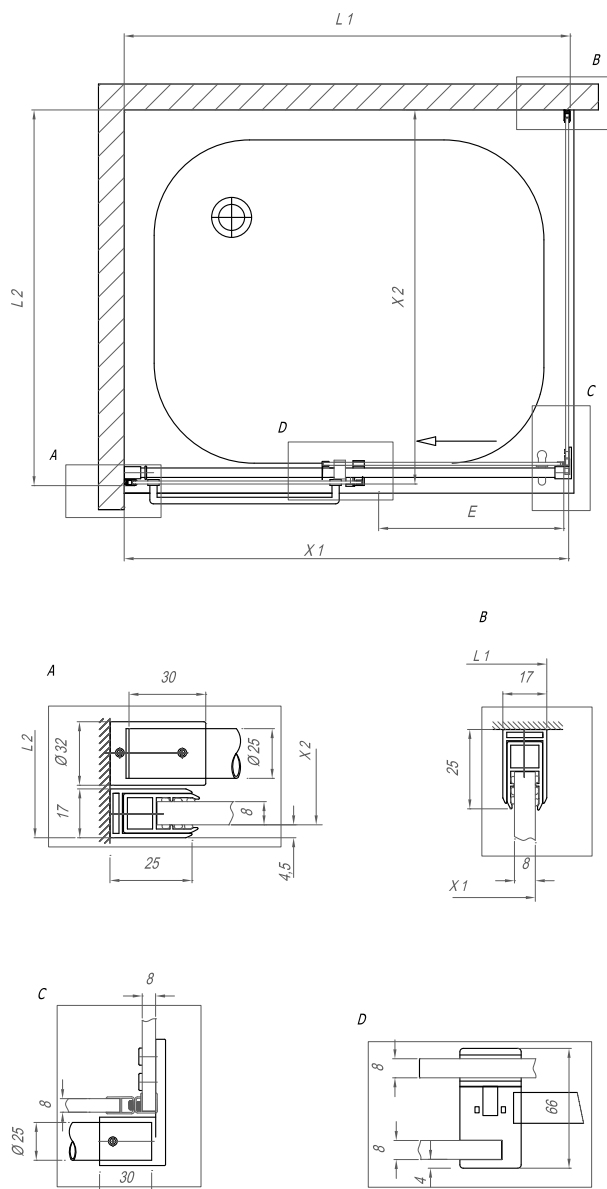

Virgo UNI TK 160, 140, 120

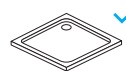

✓ Ballo, Tello, Lavolta, Lerock zero, Ramona tray, Limbo, Re-walk, Acro, Pandora Tray, Canary, Serra, Drop, Flamenco, Funky, Evelin Tray Q.

Virgo UNI			L1	L2	X1	X2		E	
TK 160 x 90			1585 - 1590	890 - 895	1580 - 1585	885 - 890	2000	660	
TK 160 x 80			1585 - 1590	790 - 795	1580 - 1585	785 - 790	2000	660	
TK 140 x 90			1385 - 1390	890 - 895	1380 - 1385	885 - 890	2000	560	
TK 140 x 80			1385 - 1390	790 - 795	1380 - 1385	785 - 790	2000	560	
TK 120 x 90 (BLACK)			1185 - 1190	890 - 895	1180 - 1185	885 - 890	2000	460	
TK 120 x 80 (BLACK)			1185 - 1190	790 - 795	1180 - 1185	785 - 790	2000	460	

# Virgo UNI TV2D/S 160, 140, 120

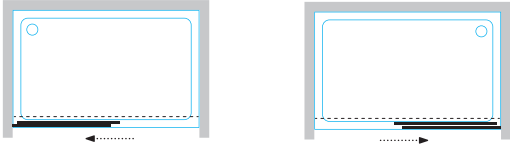

## TV2D/S 160, 140, 120

- Self-supporting shower door, single-side opening.
- Gleittür 2-teilig mit Festfeld in Nische
- Самостоятельные двери для душевой кабины, односторчатое открывание
- Önálló zuhanyajtó, egyirányú nyitással.

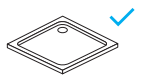
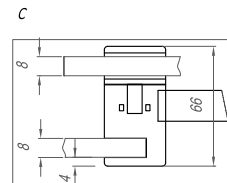
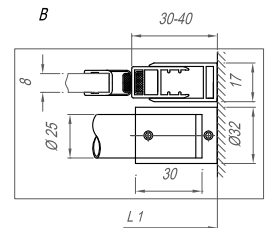
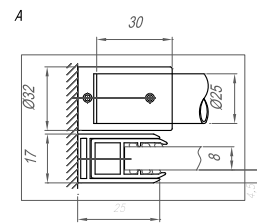
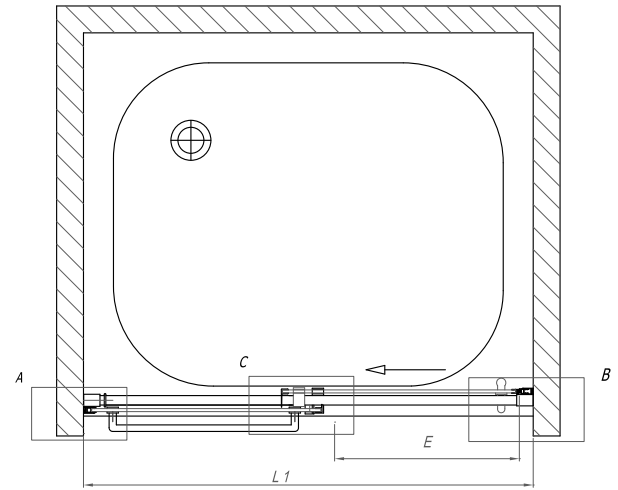

Ballo, Tello, Lavolta, Lerock zero, Ramona tray, Limbo, Re-walk, Acro, Pandora Tray, Canary, Serra, Drop, Flamenco, Funky, Evelin Tray Q.

Virgo UNI			L1	L2	X1	X2		E	
TV2D/S 160			1580 - 1600				2000	660	
TV2D/S 140			1380 - 1400				2000	560	
TV2D/S 120			1180 - 1200				2000	460	

176



Montes

# MONTES



 <p><b>8 mm</b></p>	<p><b>8 mm transparent tempered glass</b>        8 mm transparentes gehärtetes Glas        8 мм прозрачное закаленное стекло        8 mm átlátszó edzett üveg</p>	 
 <p><b>2000 mm</b></p>	<p><b>Silver Brill Studs (high gloss-polished silver galvanised coating)</b>        Silber Brill Profile (hochglanzpolierte silberne galvanische Beschichtung)        Серебристые профили бриллиант (серебряное гальваническое покрытие высококачественной полировки)        Ezüst Brill profilok (magas fényezésű ezüst galvanizált burkolat)</p>	  <p>SBR</p>
	<p><b>magnetic edge closure</b>        Magnetprofil-Verschluss        закрытие с магнитным профилем        zárás mágneses profillal</p>	
	<p><b>demounting cover</b>        Demontage der Abdeckung        рычажка для демонтажа        leválasztó fedél</p>	
	<p><b>an additional aluminium edge on the shower tray prevents overflow</b>        ein zusätzliches Alu-Profil auf der Duschwanne verhindert das Auslaufen von Wasser        дополнительные алюминиевые профили на поддоне, предотвращающие утечку воды        kiegészítő alumínium profil, amely megakadályozza a víz kifolyását</p>	

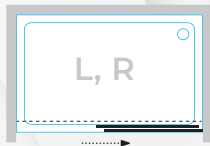
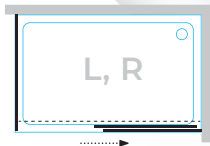

# Montes TK 140, 120 - L, R

178

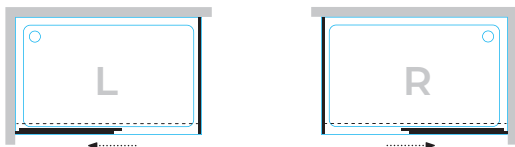

## TK 140, 120

- Shower enclosure - door and wall, left or right-side opening
- Gleittür 2-teilig mit Festfeld + Seitenwand
- Душевая кабина - дверь и стенка, одностворчатое открывание вправо или влево
- Zuhanykabin - ajtó és fal, bal vagy jobb, egyirányú nyitással.

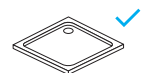
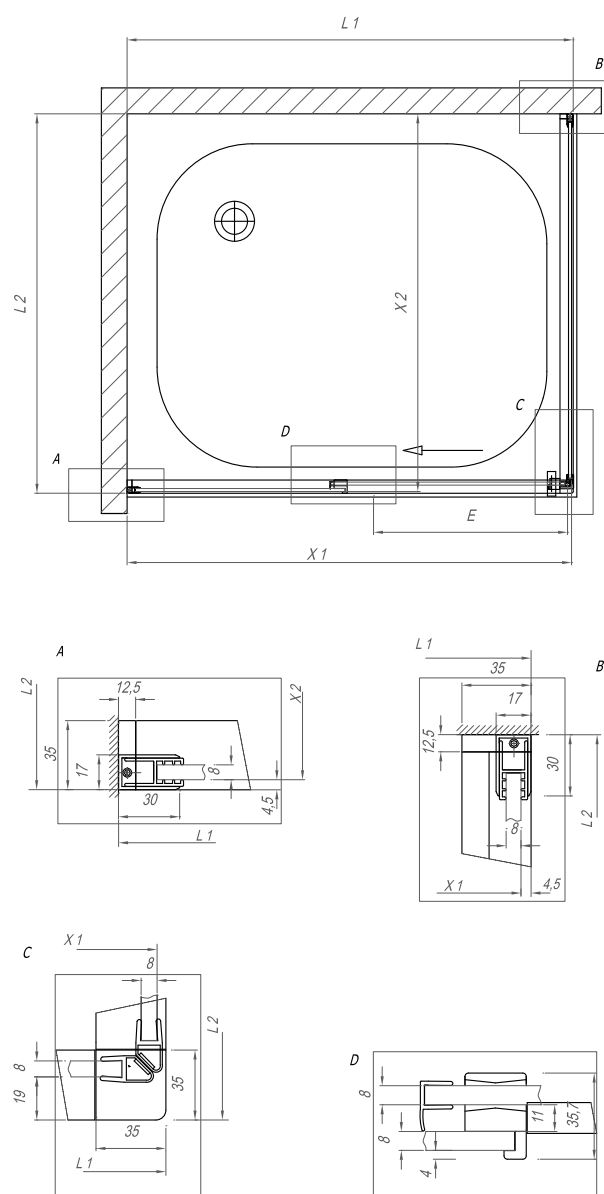
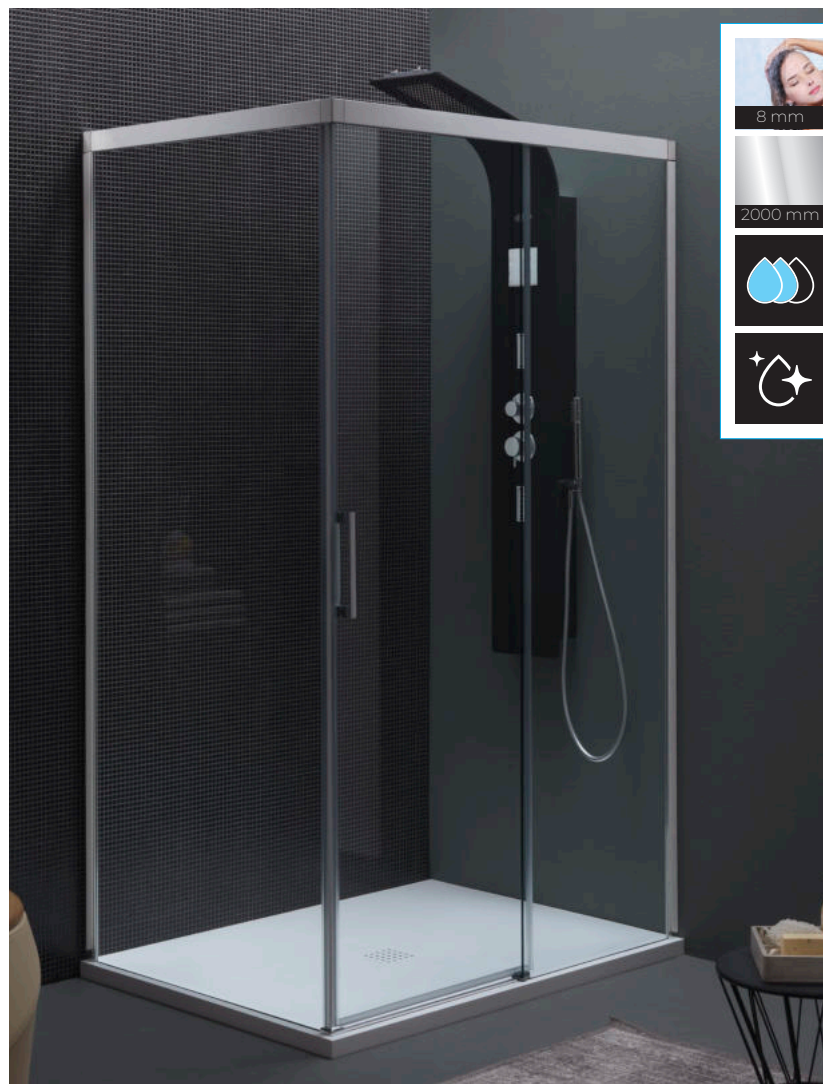

Ballo, Tello, Lavolta, Lerock zero, Ramona tray, Limbo, Re-walk, Acro, Pandora Tray, Canary, Serra, Drop, Flamenco, Funky, Evelin Tray Q.

Montes			L1	L2	X1	X2		E	
TK 140 x 90 -L, R			1380	880	1375	875	2000	560	
TK 140 x 80 -L, R			1380	780	1375	775	2000	560	
TK 120 x 90 -L, R			1180	880	1175	875	2000	460	
TK 120 x 80 -L, R			1180	780	1175	775	2000	460	

# Montes TV2D/S 140, 120 - L, R

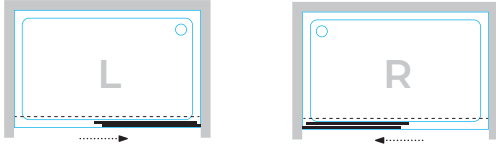

## TV2D/S 140, 120

- Self-supporting shower door, single-side opening.
- Gleittür 2-teilig mit Festfeld in Nische
- Самостоятельные двери для душевой кабины, односторчатое открывание
- Önálló zuhanyajtó, egyirányú nyitással.

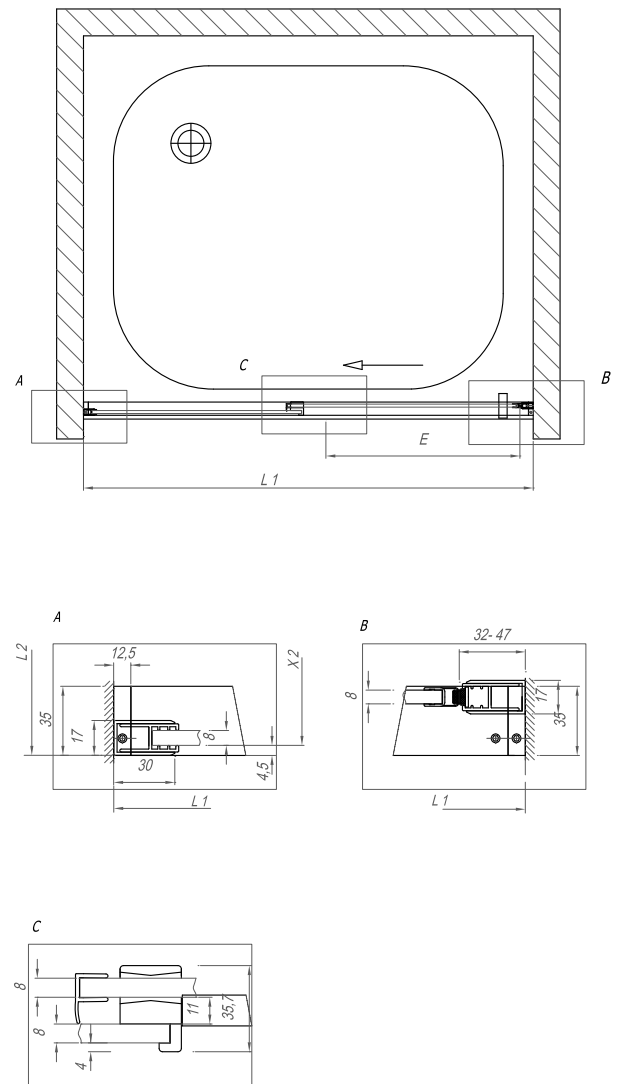

✓ Ballo, Tello, Lavolta, Lerock zero, Ramona tray, Limbo, Re-walk, Acro, Pandora Tray, Canary, Serra, Drop, Flamenco, Funky, Evelin Tray Q.

Montes			L1	L2	X1	X2		E	
TV2D/S 140 -L, R			1385- 1400				2000	597	
TV2D/S 120 -L, R			1185- 1200				2000	497	



Dorsa UNI

# DORSA UNI

 <p>8 mm</p>	<p><b>8 mm transparent tempered glass</b>                  8 mm transparentes gehärtetes Glas                  8 мм прозрачное закаленное стекло                  8 mm átlátszó edzett üveg</p>	 
 <p>2000 mm</p>	<p><b>Silver Brill Studs</b> (high gloss-polished silver galvanised coating)                  Silver Brill profilí (visokopolirana srebrna galvanska prevlaka)                  Серебристые профили бриллиант (серебряное гальваническое покрытие высококачественной полировки)                  Ezüst Brill profilok (magas fényezésű ezüst galvanizált burkolat)</p>	  <p>SBR</p>
	<p><b>magnetic edge closure</b>                  Magnetprofil-Verschluss                  закрытие с магнитным профилем                  zárás mágneses profillal</p>	
	<p><b>an additional aluminium edge on the shower tray prevents overflow</b>                  ein zusätzliches Alu-Profil auf der Duschwanne verhindert das Auslaufen von Wasser                  дополнительные алюминиевые профили на поддоне, предотвращающие утечку воды                  kiegészítő alumínium profil, amely megakadályozza a víz kifolyását</p>	
	<p><b>Clean coat, protective coating</b>                  Clean coat, Schutzbeschichtung                  Clean coat защитное покрытие                  Clean coat, védőbevonat</p>	

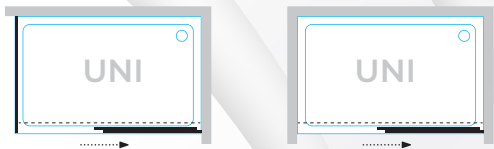

# Dorsa TK 140, 120 UNI

182

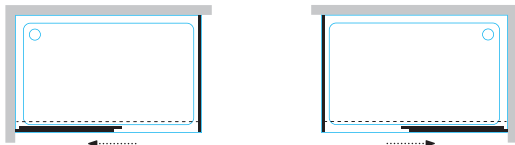

## TK 140, 120

- Shower enclosure - door and wall, left or right-side opening, universal.
- Gleittür 2-teilig mit Festfeld + Seitenwand, universell.
- Душевая кабина - дверь и стенка, одностворчатое открывание вправо или влево, универсальный.
- Zuhanykabin - ajtó és fal, bal vagy jobb, egyirányú nyitással, megfordítható.

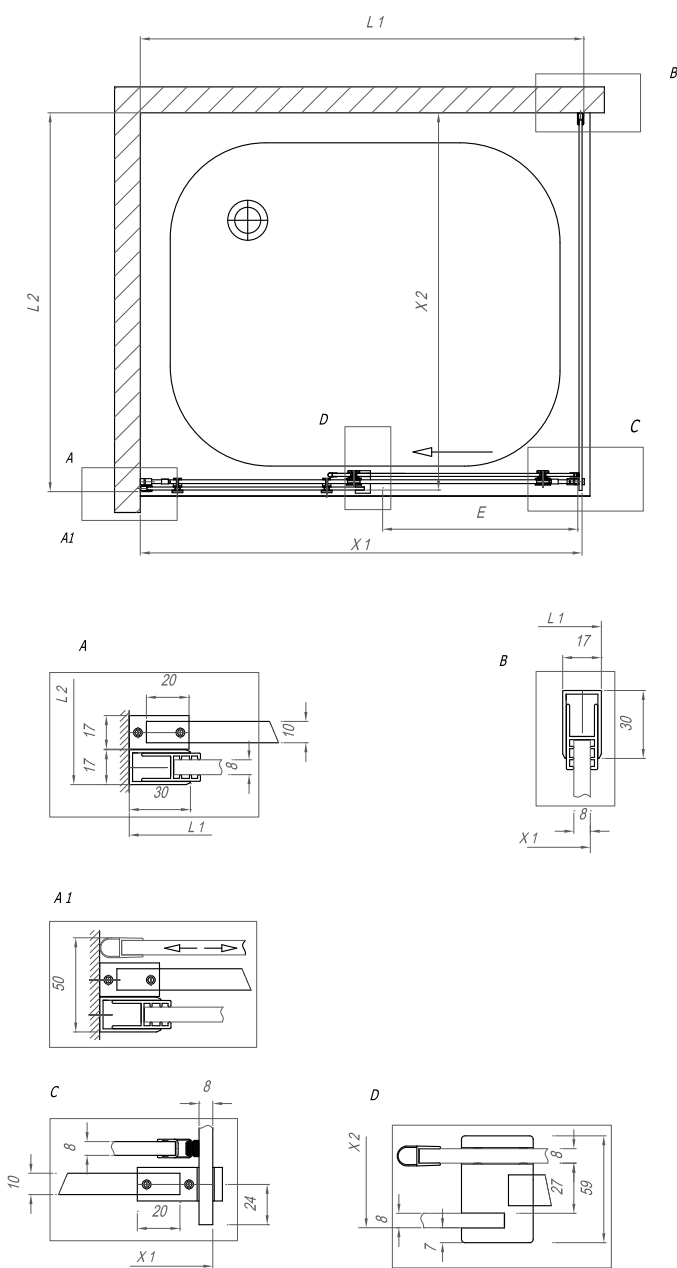

Dorsa TK 160, 140, 120 UNI

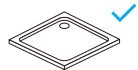

Ballo, Tello, Lavolta, Lerock zero, Ramona tray, Limbo, Re-walk, Acro, Pandora Tray, Canary, Serra, Drop, Flamenco, Evelin Tray Q.

Dorsa			L1	L2	X1	X2		E	
TK 140 x 90			1370 - 1440	885 - 895	1366 - 1436	881 - 891	2000	600 - 670	
TK 140 x 80			1370 - 1440	785 - 795	1366 - 1436	781 - 791	2000	600 - 670	
TK 120 x 90			1170 - 1240	885 - 895	1166 - 1236	881 - 891	2000	500 - 570	
TK 120 x 80			1170 - 1240	785 - 795	1166 - 1236	781 - 791	2000	500 - 570	

# Dorsa TV2D/S 140, 120 UNI

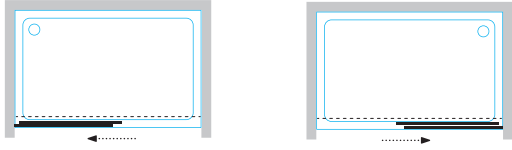

## TV2D/S 140, 120

- Self-supporting shower door, single-side opening, universal.
- Gleittür 2-teilig mit Festfeld in Nische, universell.
- Самостоятельные двери для душевой кабины, одностворчатое открывание, универсальный.
- Önálló zuhanyajtó, egyirányú nyitással, megfordítható.

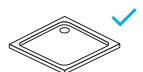
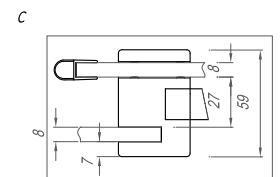
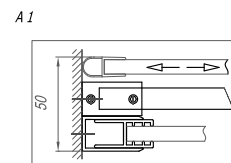
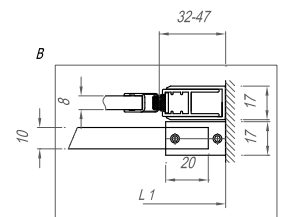
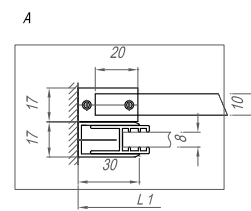
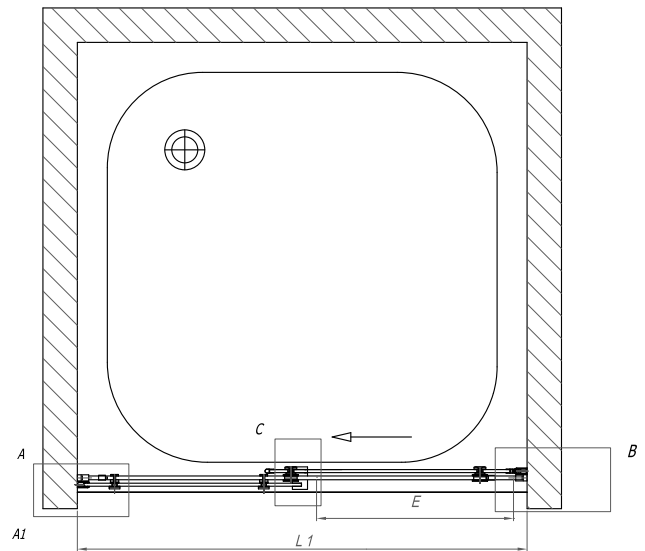
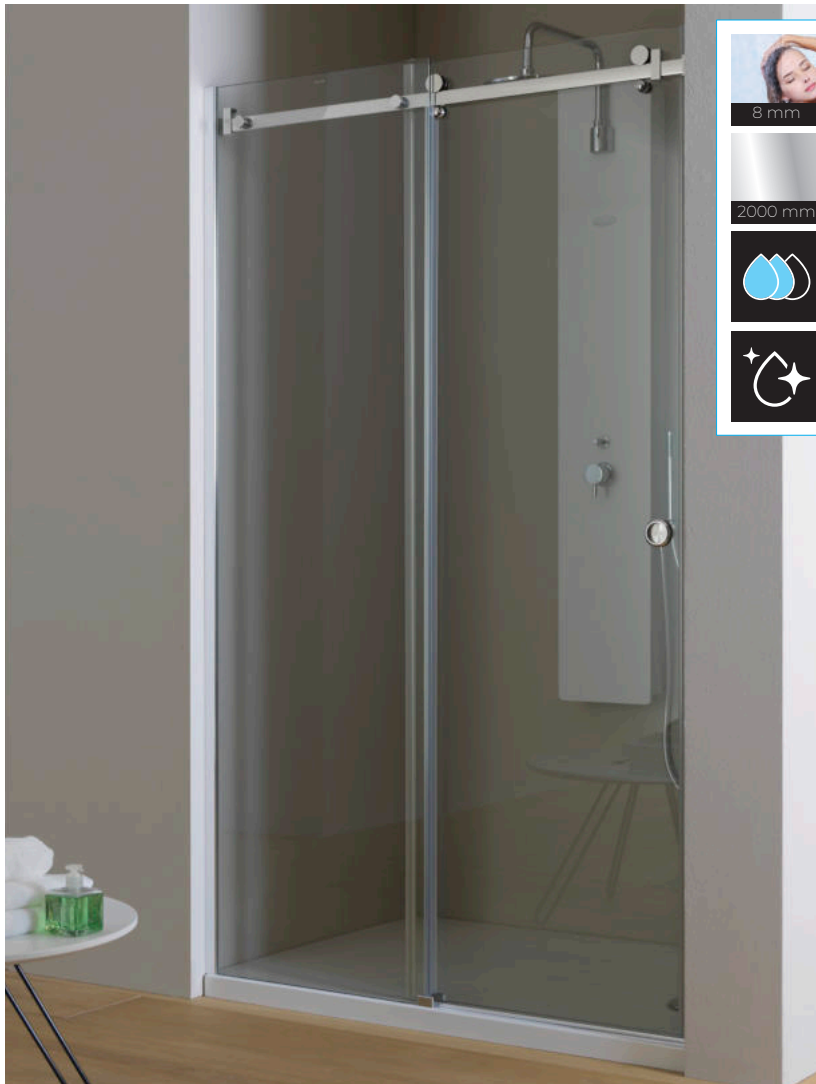









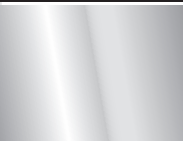

Ballo, Tello, Lavolta, Lerock zero, Ramona tray, Limbo, Re-walk, Acro, Pandora Tray, Canary, Serra, Drop, Flamenco, Evelin Tray Q.

Dorsa			L1	L2	X1	X2		E	
TV2D/S 140			1370- 1450				2000	575 - 655	
TV2D/S 120			1170- 1250				2000	475 - 555	

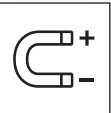

# PULSAR



 <b>6 mm</b>	<p><b>6 mm transparent tempered glass</b>          6 mm transparentes gehärtetes Glas          6 мм прозрачное закаленное стекло          6 mm átlátszó edzett üveg</p>	 
 <b>2000 mm</b>	<p><b>Silver Studs (silver galvanised coating)</b>          Silber Profile (silberne galvanische Beschichtung)          Серебряные шпильки (серебро оцинкованное покрытие)          Ezüst profilok (Ezüst szegecssek (ezüst horganyzott bevonat)</p>	 
	<p><b>magnetic edge closure</b>          Magnetprofil-Verschluss          закрытие с магнитным профилем          zárás mágneses profillal</p>	
	<p><b>detachable door panels for easy cleaning</b>          abnehmbare Türen ermöglichen einfachere Reinigung          съемные двери, позволяющие легкую очистку          a könnyen leemelhető ajtószárnyak könnyed tisztítást tesznek lehetővé</p>	
	<p><b>lower removable guide</b>          untere Demontageführung          нижнее снимающееся устройство          alsó kiszerezési konzol</p>	
	<p><b>low bottom profile</b>          niedriges unteres Profil          низкий нижний профиль          alacsony alsóprofil</p>	

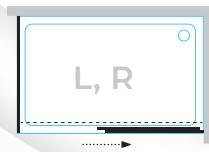
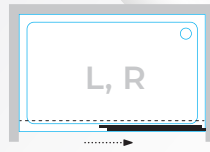
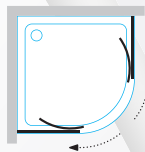
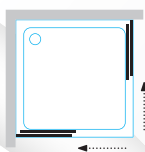

# Pulsar TKK 100, 90

186



## TKK 100, 90

- **Corner shower enclosure.** Door panels on ball bearings, detachable for easier cleaning. Possibility of being mounted on one wall with the help of an additional shower wall.
- **Eckeingang 2-teilig mit Gleittüren.** Für einfachere Reinigung können die Türflügel herausgenommen werden. Einbaumöglichkeit entlang einer Wand mit Hilfe einer zusätzlichen Duschwand.
- **Угловая душевая кабина.** Съёмные дверные части на шариковых подшипниках, которые позволяют лёгкую очистку. Возможность установки вдоль одной стены с помощью дополнительной душевой стенки.
- **Szögletes zuhanykabin.** Levehető ajtószárnyak golyóscsapágyakon, amelyek könnyebb tisztítást tesznek lehetővé. Kiegészítő zuhanyfallal egy fal mentén is elhelyezhető.

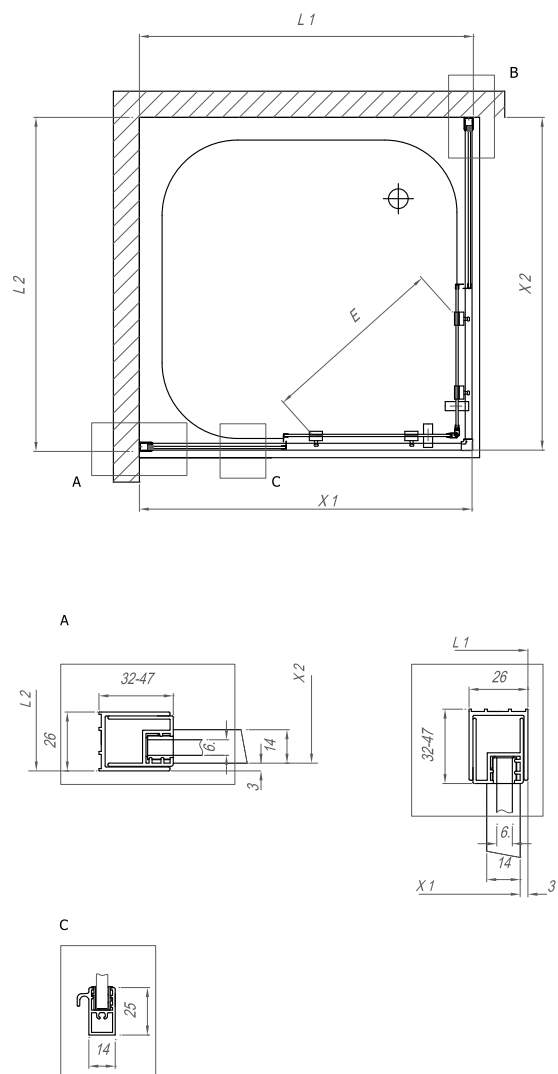
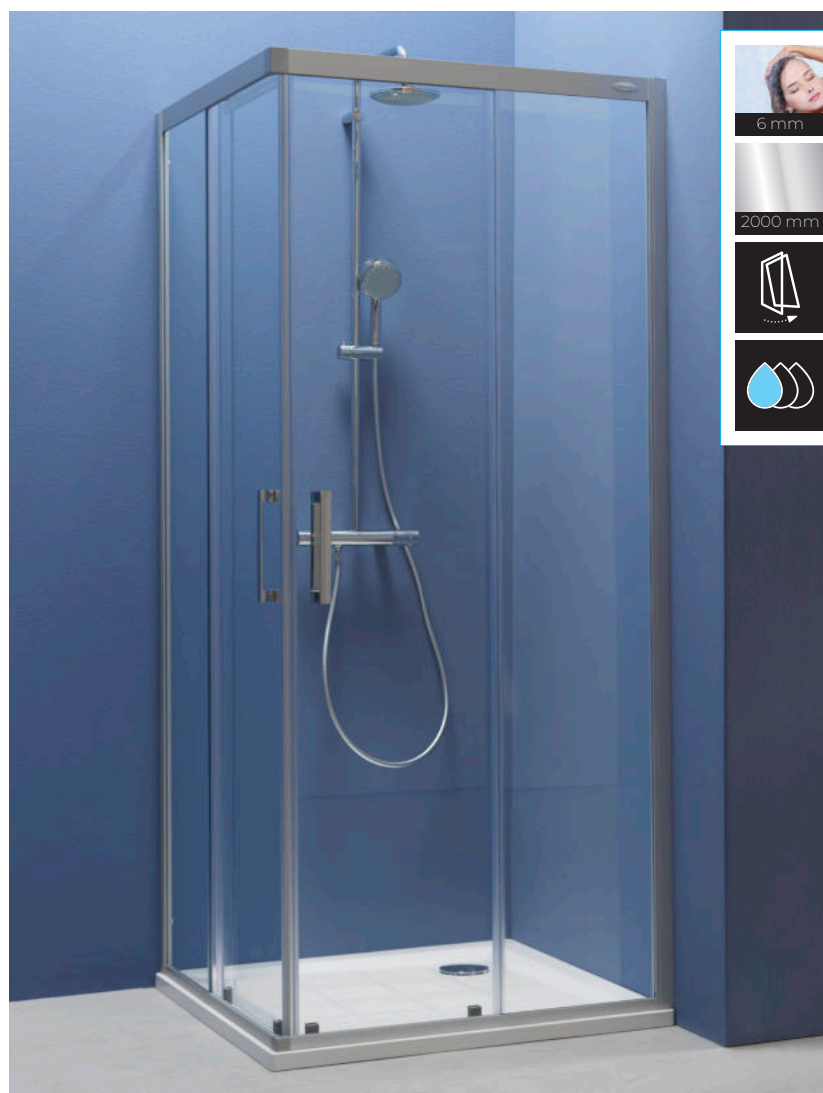

Pulsar TKK 100, 90



Tello, Lavolta, Lerock zero, Ramona tray, Funky, Limbo, Re-walk, Acro, Pandora Tray, Canary, Serra, Drop, Flamenco, Evelin Tray Q, Trin.

Pulsar			L1	L2	X1	X2		E	
TKK 100			985 - 1000	985 - 1000	982 - 997	982 - 997	2000	510	
TKK 90			885 - 900	885 - 900	882 - 897	882 - 897	2000	495	

# Pulsar TKP 100, 90

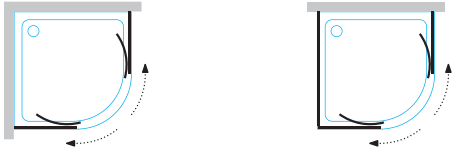

## TKP 100, 90

- **Semi-circular shower enclosure.** Door panels on ball bearings, detachable for easier cleaning. Possibility of being mounted on one wall with the help of an additional shower wall.
- **Viertelkreis- Duschkabine mit Gleittüren.** Für einfachere Reinigung können die Türflügel herausgenommen werden. Einbaumöglichkeit entlang einer Wand mit Hilfe einer zusätzlichen Duschwand.
- **Полукруглая душевая кабина.** Съёмные дверные части на шариковых подшипниках, которые позволяют лёгкую очистку. Возможность установки вдоль одной стены с помощью дополнительной душевой стенки.
- **Félköríves zuhanykabin.** Levehető ajtószárnyak golyóscsapágyakon, amelyek könnyebb tisztítást tesznek lehetővé. Kiegészítő zuhanyfallal egy fal mentén is elhelyezhető.

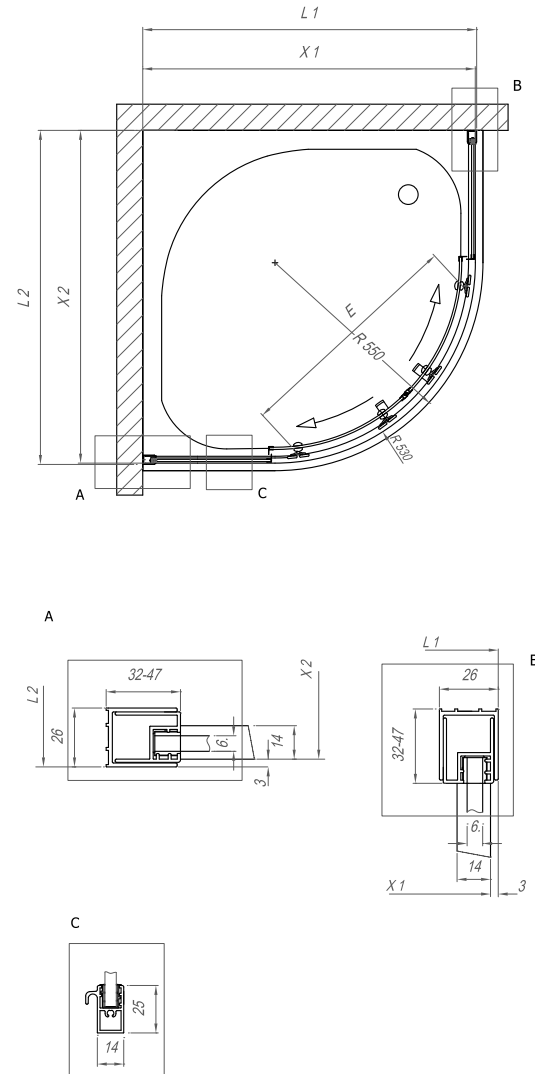

Lavolta R, Moonwalk R, Macarena, Drop R, Malur, Dixie, Evelin Tray R, Ontex.

Pulsar			L1	L2	X1	X2			E	
TKP 100			985 - 995	985 - 995	982 - 992	982 - 992	550	2000	510	
TKP 90			885 - 895	885 - 895	882 - 892	882 - 892	550	2000	495	

# Pulsar TV2D/s 120, 100

188

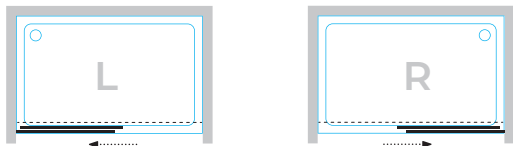

## TV2D/s 120, 100

- Self-supporting shower door, single-side opening.
- Gleittür 2-teilig mit Festfeld in Nische.
- Самостоятельные двери для душевой кабины, одностворчатое открывание.
- Onálló zuhanyajtó, egyirányú nyitással.

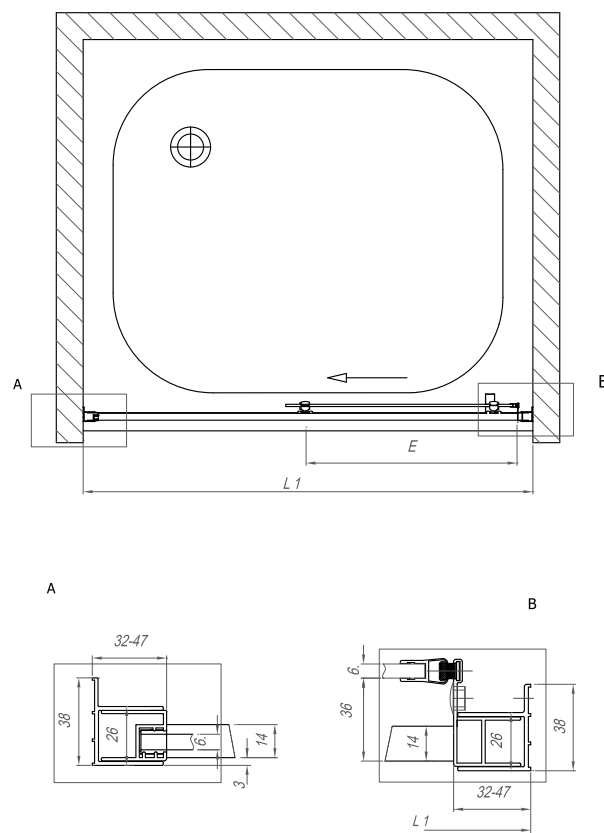

Pulsar TV2D/s 120, 100 - L, R

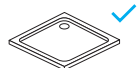

Ballo, Tello, Lavolta, Lerock zero, Ramona tray, Limbo, Re-walk, Acro, Pandora Tray, Canary, Serra, Drop, Flamenco, Funky, Evelin Tray Q.

Pulsar			L1	L2	X1	X2		E	
TV2D/S 120 - L, R			1175 - 1200				2000	510	
TV2D/S 100 - L, R			975 - 1000				2000	410	

# Pulsar TV2D/s 120, 100 - L, R + TS 90, 80

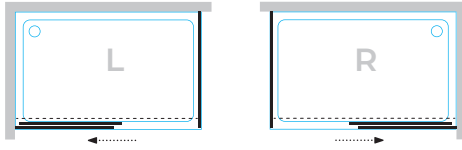

## TV2D/s 120, 100 - L, R + TS 90, 80

- Shower enclosure - door and wall, left or right-side opening.
- Gleittür 2-teilig mit Festfeld + Seitenwand.
- Душевая кабина - дверь и стенка, одностворчатое открывание вправо или влево.
- Zuhanykabin - ajtó és fal, bal vagy jobb egyirányú nyitással.

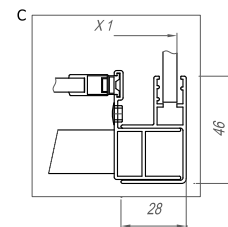
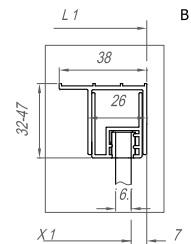
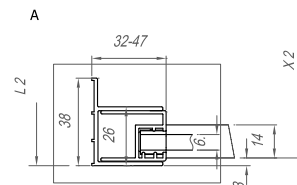
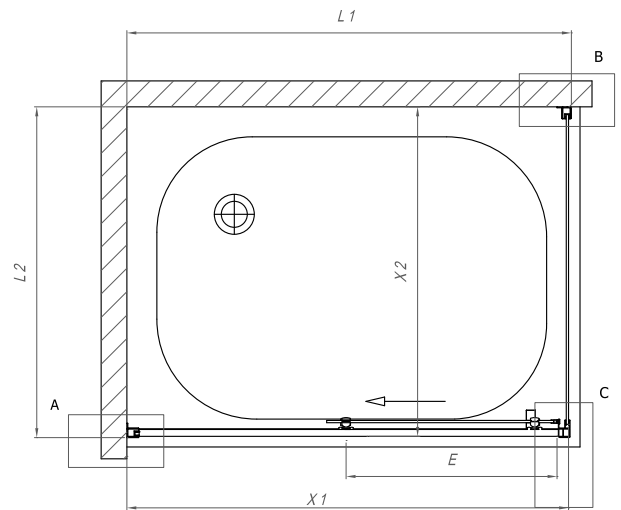

Ballo, Tello, Lavolta, Lerock zero, Ramona tray, Limbo, Re-walk, Acro, Pandora Tray, Canary, Serra, Drop, Flamenco, Funky, Evelin Tray Q.

Pulsar			L1	L2	X1	X2		E	
TV2D/S 120 - L, R			1175 - 1190		1168 - 1183		2000	510	
TV2D/S 100 - L, R			975 - 900		968 - 983		2000	410	
TS 90				875 - 890		872 - 887	2000		
TS 80				775 - 790		772 - 787	2000		

### Additional profiles

Zusätzliche Profile

Дополнительные профили

Kiegészítő profilok

190



Version with the compensational profile K 25 for TKK, TKP, TV and TS.

Variante mit Ausgleichprofil K 25 für TKK, TKP, TV und TS.

Вариант с дополнительным профилем K 25 для ТКК, ТКП, ТВ и ТС.

Variáció K 25 toldóprofilal – TKK, TKP, TV, TS -nél.

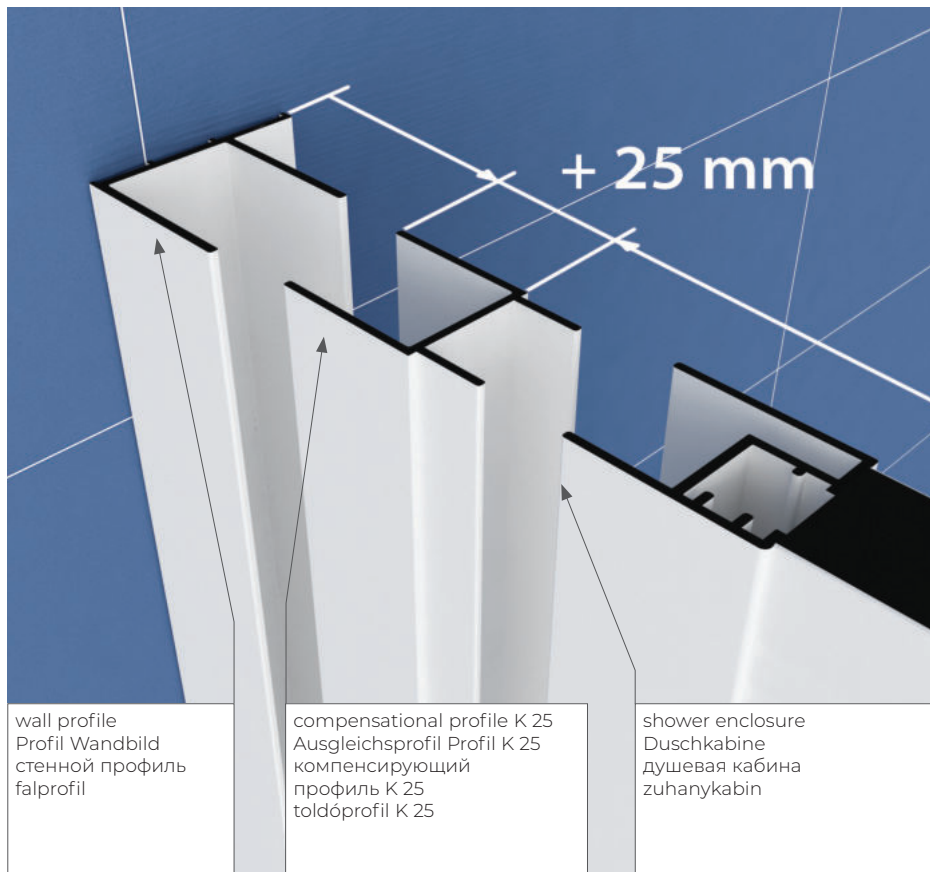

wall profile  
Profil Wandbild  
стенной профиль  
falprofil

compensational profile K 25  
Ausgleichsprofil Profil K 25  
компенсирующий  
профиль K 25  
toldóprofil K 25

shower enclosure  
Duschkabine  
душевая кабина  
zuhanykabin

Type/Typ/Тип/ Típus	Type of profile / Profiltyp / Вид профиля / Profiltípus		
K 25 Pulsar	additional profile for TKK, TKP, TV, TS Pulsar / Zusätzliches Profil für TKK, TKP, TV, TS Pulsar / дополнительный профиль для Линия ТКК, ТКП, ТВ, ТС Pulsar kiegészítő profil TKK, TKP, TV, TS típusokhloy Pulsar	2000	25





# SQ LINE



 <b>5/6 mm</b>	<p><b>5/6 mm transparent tempered glass</b>                  5/6 mm transparentes gehärtetes Glas                  5/6 мм прозрачное закаленное стекло                  5/6 mm átlátszó edzett üveg</p>	 
 <b>5/6 mm</b>	<p><b>5/6 mm chinchilla tempered glass</b>                  5/6 m Chinchilla gehärtetes Glas                  5/6 мм закаленное стекло "шиншилла"                  5/6 mm chinchilla edzett üveg</p>	 
 <b>1900 mm 1600 mm</b>	<p><b>Silver Studs (silver galvanised coating)</b>                  Silber Profile (silberne galvanische Beschichtung)                  Серебряные шпильки (серебро оцинкованное покрытие)                  Ezüst profilok (Ezüst szegecsek (ezüst horganyzott bevonat)</p>	 
 <b>1900 mm 1600 mm</b>	<p><b>White Studs (powder coating)</b>                  Weiße Profile (Pulverbeschichtung)                  Белый профиль (порошковое покрытие)                  Fehér profilok (porlakkozás)</p>	 
	<p><b>magnetic edge closure</b>                  Magnetprofil-Verschluss                  закрытие с магнитным профилем                  zárás mágneses profillal</p>	
	<p><b>the possibility of compensation profiles</b>                  das Möglichkeit von Zusätzliche Profile                  варианты компенсационных профилей                  krómozott pántok emelőfunkcióval</p>	
	<p><b>detachable door panels for easy cleaning</b>                  abnehmbare Türen ermöglichen einfachere Reinigung                  съемные двери, позволяющие легкую очистку                  a könnyen leemelhető ajtószárnyak könnyed tisztítást tesznek lehetővé</p>	



# SQ line TKK 120, 100, 90, 80, 70

194

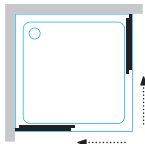

## TKK 120, 100, 90, 80, 70

- **Corner shower enclosure.** Door panels on ball bearings, detachable for easier cleaning.
- **Eckeinstieg 2-teilig mit Gleittüren.** Für einfachere Reinigung können die Türflügel herausgenommen werden.
- **Угловая душевая кабина.** Съёмные дверные части на шариковых подшипниках, которые позволяют лёгкую очистку.
- **Szögletes zuhanykabin.** Levehető ajtószárnyak golyóscsapágyakon, amelyek könnyebb tisztítást tesznek lehetővé.

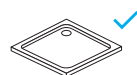
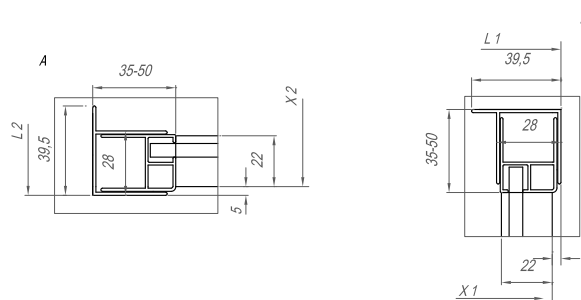
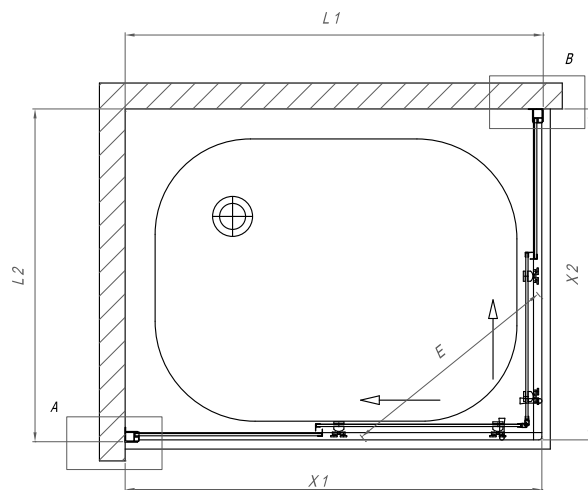

Tello, Lavolta, Lerock zero, Ramona tray, Funky, Limbo, Re-walk, Acro, Pandora Tray, Canary, Serra, Drop, Flamenco, Evelin Tray Q, Trin.

SQ line			L1	L2	X1	X2	↑	E	
TKK 120x90			1180 - 1195	880 - 895	1175 - 1190	875 - 890	1900	590	
TKK 120x80			1180 - 1195	780 - 795	1175 - 1190	775 - 790	1900	565	
TKK 100x90			980 - 995	880 - 895	975 - 990	875 - 890	1900	560	
TKK 100x80			980 - 995	780 - 795	975 - 990	775 - 790	1900	500	
TKK 90x80			880 - 895	780 - 795	875 - 890	775 - 790	1900	480	
TKK 90x75			880 - 895	730 - 745	875 - 890	725 - 740	1900	450	
TKK 90x70			880 - 895	680 - 695	875 - 890	675 - 690	1900	420	
TKK 100			980 - 995	980 - 995	975 - 990	975 - 990	1900	580	
TKK 90			880 - 895	880 - 895	875 - 890	875 - 890	1900	480	
TKK 80			780 - 795	780 - 795	775 - 790	775 - 790	1900	420	
TKK 70			680 - 695	680 - 695	675 - 690	675 - 690	1900	370	

# SQ line TKP 120, 100, 90, 80

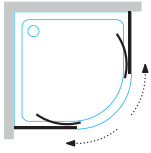

## TKP 120, 100, 90, 80

- Semi-circular shower enclosure. Door panels on ball bearings, detachable for easier cleaning.
- Viertelkreis- Duschkabine mit Gleittüren. Für einfachere Reinigung können die Türflügel herausgenommen werden.
- Полукруглая душевая кабина. Съёмные дверные части на шариковых подшипниках, которые позволяют лёгкую очистку.
- Félköríves zuhanykabin. Levehető ajtószárnyak golyóscsapágyakon, amelyek könnyebb tisztítást tesznek lehetővé.

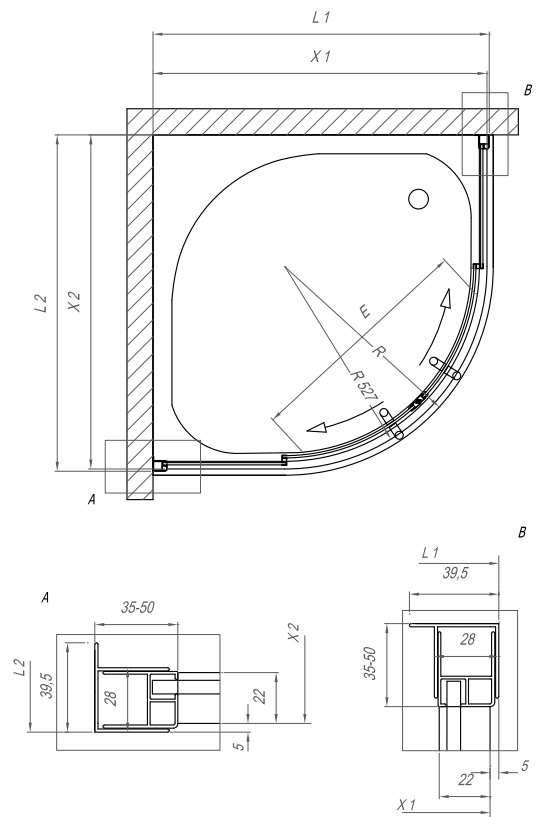

✓ Lavolta R, Moonwalk R, Macarena, Drop R, Malur, Dixie, Evelin Tray R, Ontex.

SQ line			L1	L2	X1	X2			E		
TKP 120x90			1180 - 1195	880 - 895	1175 - 1190	875 - 890		550	1900	530	
TKP 100x80			980 - 995	780 - 795	975 - 990	775 - 790		550	1900	490	
TKP 100			980 - 995	980 - 995	975 - 990	975 - 990		550	1900	520	
TKP 90			880 - 895	880 - 895	875 - 890	875 - 890		550	1900	520	
TKP 80			780 - 795	780 - 795	775 - 790	775 - 790		550	1900	420	

# SQ line TV2D/S 130, 120, 110, 100

196

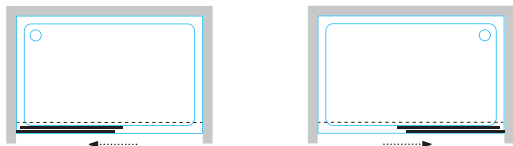

## TV2D/S 130, 120, 110, 100

- **Two-piece shower door.** Door panels on ball bearings, detachable for easier cleaning. Left or right hand versions.
- **Zweiteilige Duschtür.** Für einfachere Reinigung können die Türflügel herausgenommen werden. Linke oder rechte Variante mit Drehen der Türen oder Wände.
- **Душевая дверь двухстворчатая.** Съёмные дверные части на шариковых подшипниках, которые позволяют лёгкую очистку. Левая или правая версия с поворачиванием дверей или стенки.
- **Kétrészes zuhanyajtó.** Balos- vagy jobbos beépítési lehetőség Variáció: az ajtó vagy a fal nyitásával. Baloldali és jobboldali változat az ajtó, vagy a fal forgatásával.

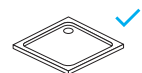
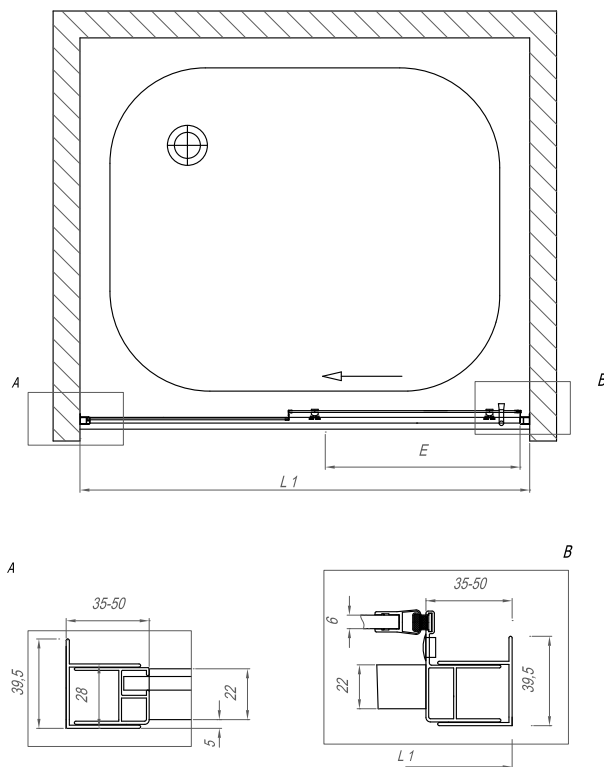

Tello, Lavolta, Lerock zero, Ramona tray, Stiletto, Limbo, Re-walk, Acro, Pandora Tray, Canary, Serra, Drop, Flamenco, Funky, Evelin Tray Q.

SQ line			L1	L2	X1	X2		E	
TV2D/S 130			1275 - 1300				1900	520	
TV2D/S 120			1175 - 1200				1900	510	
TV2D/S 110			1075 - 1100				1900	480	
TV2D/S 100			975 - 1000				1900	410	

# SQ line TV2D/S + TS 90, 80, 75, 70

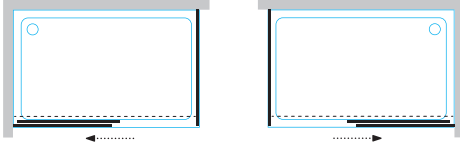

### TV2D/S + TS 90, 80, 75, 70

- **Two-piece shower door with shower wall.** Door panels on ball bearings, detachable for easier cleaning. Left or right hand versions.
- **Zweiteilige Duschtür mit der Duschwand.** Für einfachere Reinigung können die Türflügel herausgenommen werden. Linke oder rechte Variante mit Drehen der Türen oder Wände.
- **Душевая дверь двухстворчатая с душевой стенкой.** Съёмные дверные части на шариковых подшипниках, которые позволяют лёгкую очистку. Левая или правая версия с поворачиванием дверей или стенки.
- **Kétrészes zuhanyajtó zuhanyfallal.** Balos- vagy jobbos beépítési lehetőség Variáció: az ajtó vagy a fal nyitásával. Baloldali és jobboldali változat az ajtó, vagy a fal forgatásával.

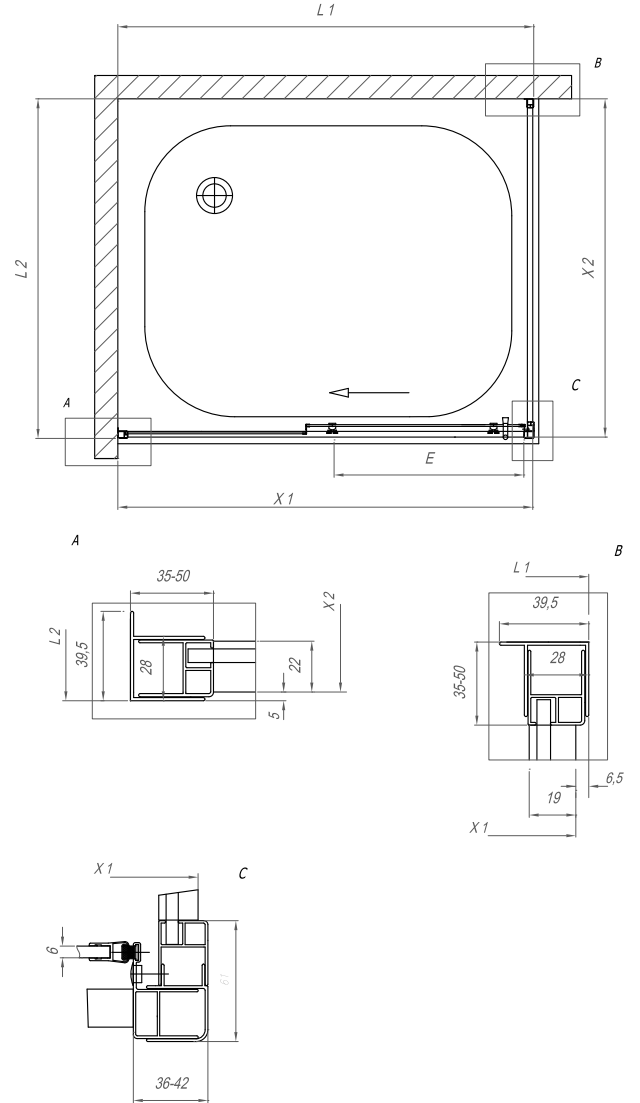

✓ Tello, Lavolta, Lerock zero, Ramona tray, Stiletto, Limbo, Re-walk, Acro, Pandora Tray, Canary, Serra, Drop, Flamenco, Funky, Evelin Tray Q.

SQ line			L1	L2	X1	X2		E	
TV2D/S 130			1275 - 1300		1268 - 1293		1900	520	
TV2D/S 120			1175 - 1200		1168 - 1193		1900	510	
TV2D/S 110			1075 - 1100		1068 - 1093		1900	480	
TV2D/S 100			975 - 1000		968 - 993		1900	410	
TS 90				880 - 895		875 - 890	1900		
TS 80				780 - 795		775 - 790	1900		
TS 75				730 - 745		725 - 740	1900		
TS 70				680 - 695		675 - 690	1900		

# SQ line TV2D/S + 2xTS 90, 80, 75, 70

198



## TV2D/S + 2xTS 90, 80, 75, 70

- Two-part shower door with two shower walls. Door panels on ball bearings, detachable for easier cleaning. Left or right hand versions.
- Zweiteilige Duschtür mit zwei Duschwänden. Für einfachere Reinigung können die Türflügel herausgenommen werden. Linke oder rechte Variante mit Drehen der Türen oder Wände.
- Двухсекционная душевая дверь с двумя душевыми стенками. Съёмные дверные части на шариковых подшипниках, которые позволяют лёгкую очистку. Левая или правая версия с поворачиванием дверей или стенки.
- Kétrészes zuhanyajtó két zuhanyfallal. Balos- vagy jobbos beépítési lehetőség Variáció: az ajtó vagy a fal nyitásával. Baloldali és jobboldali változat az ajtó, vagy a fal forgatásával.



- 5/6 mm
- 5/6 mm
- 1900 mm
- 1900 mm
- 
- 

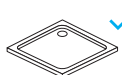
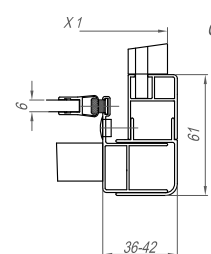
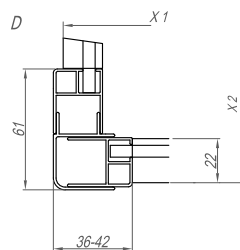
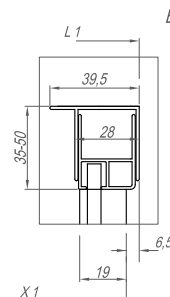
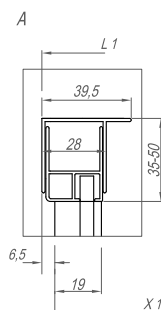
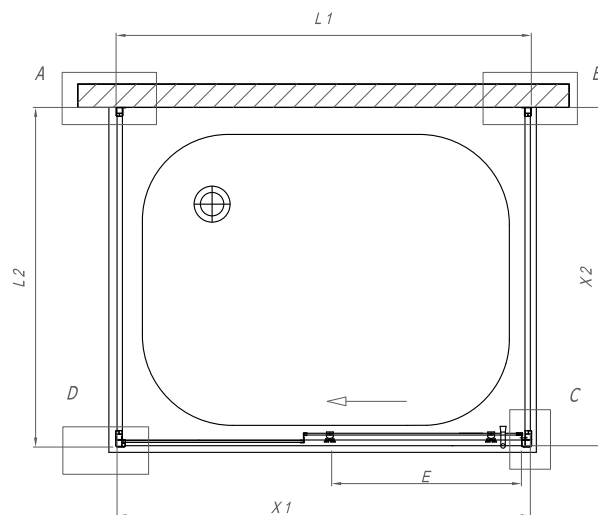

✓ Tello, Lavolta, Lerock zero, Ramona tray, Stiletto, Limbo, Re-walk, Acro, Pandora Tray, Canary, Serra, Drop, Flamenco, Funky, Evelin Tray Q.

SQ line			L1	L2	X1	X2		E	
TV2D/S 130			1275 - 1300		1268 - 1293			1900 520	
TV2D/S 120			1175 - 1200		1168 - 1193			1900 510	
TV2D/S 110			1075 - 1100		1068 - 1093			1900 480	
TV2D/S 100			975 - 1000		968 - 993			1900 410	
TS 90				880 - 895		875 - 890		1900	
TS 80				780 - 795		775 - 790		1900	
TS 75				730 - 745		725 - 740		1900	
TS 70				680 - 695		675 - 690		1900	

# SQ line TV4D/S 170, 160, 140

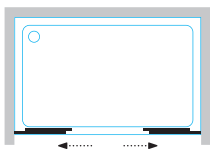

## TV4D/S 170, 160, 140

- Shower door with central position.  
Door panels on ball bearings, detachable for easier cleaning.
- Duschtür mit Öffnen in der Mitte.  
Abnehmbare Türflügel auf Kugellagern, die eine einfachere Reinigung ermöglichen.
- Душевая дверь с центральным открыванием/закрыванием.  
Съемные дверные створки, установленные на подшипниках, позволяют более легкую очистку.
- Zuhanykabinajtó középső nyitással.  
Könnyen levehető ajtók golyóscsapágyon, a könnyebb tisztítás miatt.

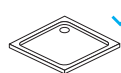
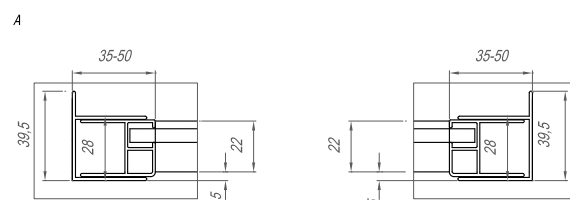
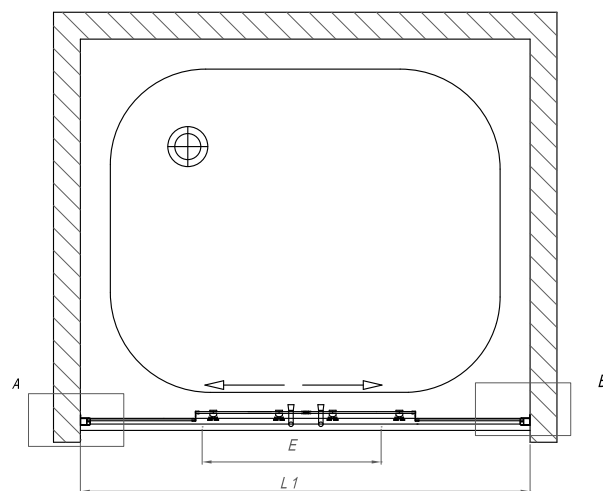

✓ Ballo, Tello, Lavolta, Limbo, Re-walk, Acro, Canary, Serra, Drop, Flamenco.

SQ line			L1	L2	X1	X2		E	
TV4D/S 170			1675 - 1700				1900	715	
TV4D/S 160			1575 - 1600				1900	630	
TV4D/S 140			1375 - 1400				1900	590	

# SQ line TV4D/S + TS 90, 80, 75, 70

200



## TV4D/S + TS 90, 80, 75, 70

- Shower door with central position with shower wall.  
Door panels on ball bearings, detachable for easier cleaning.
- Duschtür mit Öffnen in der Mitte mit der Duschwand.  
Abnehmbare Türflügel auf Kugellagern, die eine einfachere Reinigung ermöglichen.
- Душевая дверь с центральным открыванием/закрыванием с душевой стенкой.  
Съемные дверные створки, установленные на подшипниках, позволяют более легкую очистку.
- Zuhanykabinajtó középső nyitással zuhanyfallal.  
Könnyen levehető ajtók golyócsapágyon, a könnyebb tisztítás miatt.

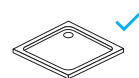
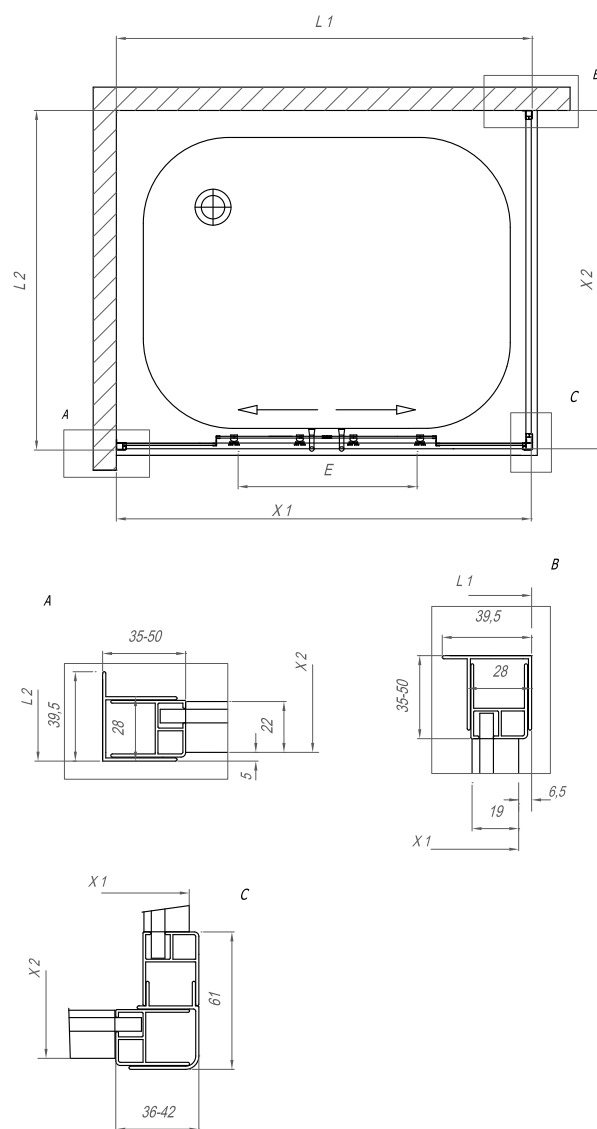

Tello, Lavolta, Lerock zero, Ramona tray, Limbo, Re-walk, Acro, Pandora Tray, Canary, Serra, Drop, Flamenco, Funky, Evelin Tray Q.

SQ line			L1	L2	X1	X2		E	
TV4D/S 120			1675 - 1700		1668 - 1693		1900	715	
TV4D/S 110			1575 - 1600		1568 - 1593		1900	630	
TV4D/S 100			1375 - 1400		1368 - 1393		1900	590	
TS 90				880 - 895		875 - 890	1900		
TS 80				780 - 795		775 - 790	1900		
TS 75				730 - 745		725 - 740	1900		
TS 70				680 - 695		675 - 690	1900		

SQ line TV4D/S + TS 90, 80, 75, 70



# SQ line TKP 90 Dixie

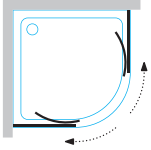

## TKP 90 Dixie

- Semi-circular shower enclosure for the Dixie shower tray.
- Door panels on ball bearings, detachable for easier cleaning, h=160.
- Halbkreisduschkabine für die Dixie Duschwanne.  
Für einfachere Reinigung können die Türflügel herausgenommen werden, H = 160.
- Полукруглая душевая кабина для душевого поддона Дикси.  
Съёмные дверные части на шариковых подшипниках, которые позволяют лёгкую очистку, h = 160.
- Félköríves zuhanykabin zuhanytálca Dixie.  
Levehető ajtószárnyak golyóscsapágyakon, amelyek könnyebb tisztítást tesznek lehetővé, h = 160.

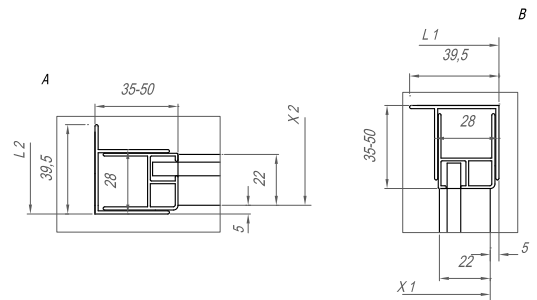
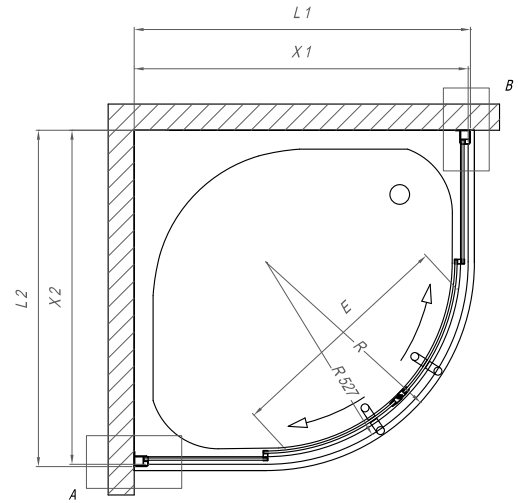

Dixie.

The product is well suited for elderly users.  
Das Produkt ist auch für die Benutzung durch ältere Personen geeignet.  
Изделие подходит для людей пожилого возраста.  
A termék megfelel az idősebb felhasználók igényeinek.

SQ line			L1	L2	X1	X2			E	
TKP 90/CH Dixie			880 - 895	880 - 895	875 - 890	875 - 890	550	1600	520	

### Additional profiles

Zusätzliche Profile

Дополнительные профили

Kiegészítő profilok

202



Version with the compensational profile K 30 for TKK, TKP, TV2D, TV4D, TV and TS.

Variante mit Ausgleichprofil K 30 für TKK, TKP, TV2D, TV4D, TV und TS.

Вариант с дополнительным профилем K 30 для ТКК, ТКП, ТВ2Д, ТВ4Д, ТВ и ТС.

Variáció K 30 toldóprofilal – TKK,TKP, TV2D, TV4D, TV, TS -nél.

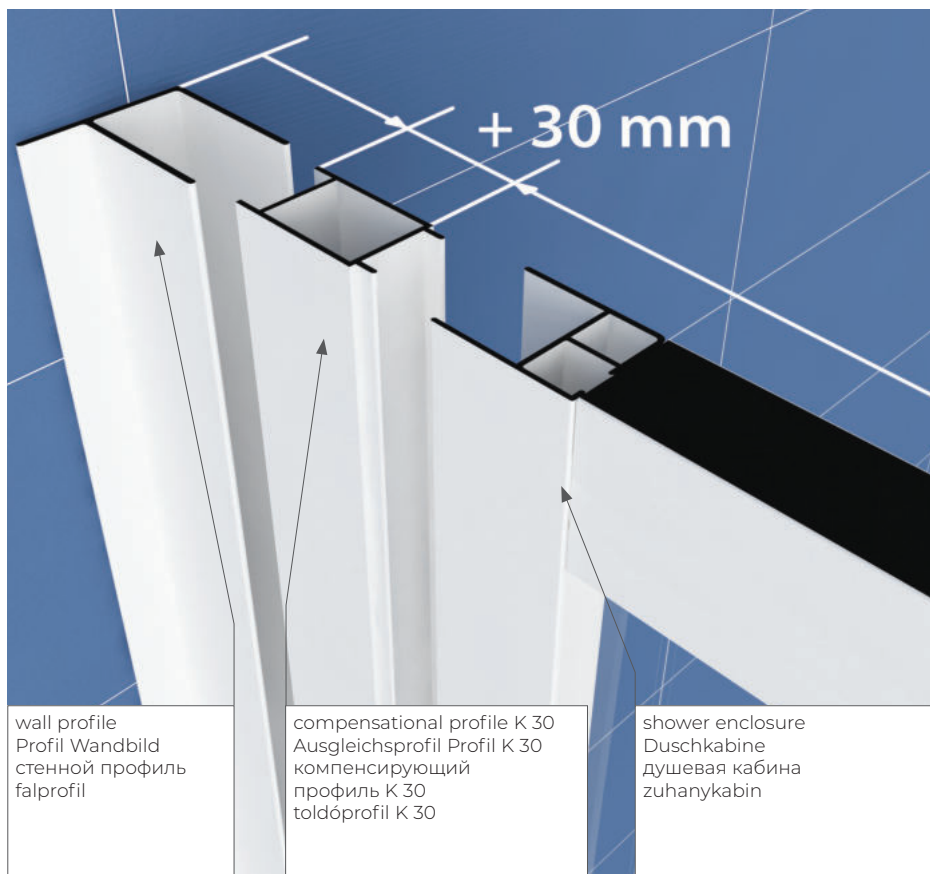

wall profile  
Profil Wandbild  
стенной профиль  
falprofil

compensational profile K 30  
Ausgleichsprofil Profil K 30  
компенсирующий  
профиль K 30  
toldóprofil K 30

shower enclosure  
Duschkabine  
душевая кабина  
zuhanykabin

Type/Typ/Тип/ Típus	Type of profile / Profiltyp / Вид профиля / Profiltípus		
K 30 SQ line	additional profile for TKK, TKP, TV2D, TV4D, TV, TS SQ line / Zusätzliches Profil für TKK, TKP, TV2D, TV4D, TV, TS SQ line/ дополнительный профиль для Линия ТКК, ТКП, ТВ2Д, ТВ4Д, ТВ, ТС SQ line kiegészítő profil TKK, TKP, TV2D, TV4D, TV, TS típusokhloy SQ line	1900	30



204



Luna

# LUNA

 <b>4/6 mm</b>	<p><b>4/6 mm transparent tempered glass</b>  4/6 mm transparentes gehärtetes Glas  4/6 мм прозрачное закаленное стекло  4/6 mm átlátszó edzett üveg</p>	 
 <b>1900 mm</b> <b>1850 mm</b>	<p><b>Silver Studs (polished silver galvanised coating)</b>  Silber Profile (polierte silberne galvanische Beschichtung)  Серебряные шпильки (полированное серебряное гальваническое покрытие)  Ezüst profilok (ezüst horganyzott bevonat)</p>	 
	<p><b>magnetic edge closure</b>  Magnetprofil-Verschluss  закрытие с магнитным профилем  zárás mágneses profillal</p>	
	<p><b>optional compensation studs K 30 for TV3D/S, TVZ/S</b>  Option von Kompensationsprofilen K 30 für TV3D/S, TVZ/S  варианты компенсационных профилей К 30 – для ТВ3Д/С, ТВЗ/С  a lehetőségét, kompenzációs profil K 30 – TV3D/S, TVZ/S -nél</p>	
	<p><b>optional compensation studs K 25 for TVO/S</b>  Option von Kompensationsprofilen K 25 für TVO/S  варианты компенсационных профилей К 25 – для ТВО/С  a lehetőségét, kompenzációs profil K 25 – TVO/S -nél</p>	

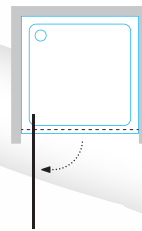
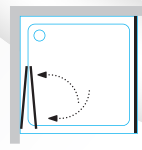
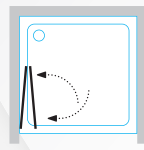
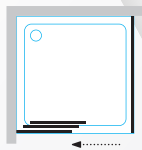
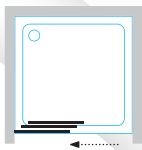

# Luna TV3D/S 100, 90, 80

206

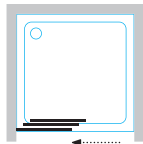

## TV3D/S 100, 90, 80

- Freestanding shower cabin, threefold.

Optional K 30 profile for non-standard cabin widths.

- Selbständige Duschtür, dreiteilige.

Zusätzliches K 30 Profil für nichtstandardmäßige Breiten von Kabinen als Option.

- Складные душевые двери, 3х-секционный. Возможность установки дополнительного профиля К 30 для установки душевых кабин нестандартных размеров по ширине.

- Önálló zuhanyajtó, háromrészes. Kiegészítő K 30-ös profil beépítésének lehetősége nem szabványos kabinszélességek esetében.

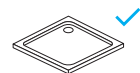
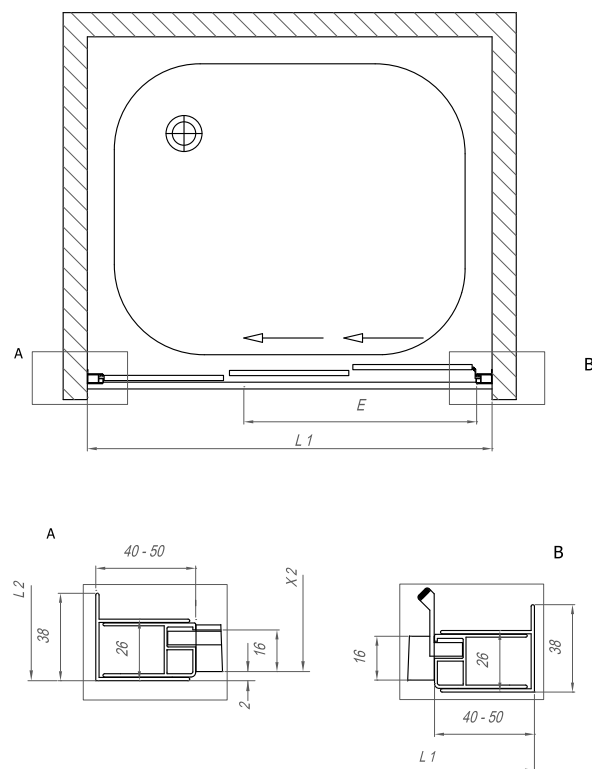

Tello, Lavolta, Lerock zero, Ramona tray, Stiletto, Limbo, Re-walk, Acro, Pandora Tray, Canary, Serra, Drop, Flamenco, Funky, Evelin Tray Q.

Luna			L1	L2	X1	X2		E	
TV3D/S 100			980 - 1000				1850	500	
TV3D/S 90			880 - 900				1850	430	
TV3D/S 80			780 - 800				1850	370	

# Luna TV3D/S + TSv3D 90, 80

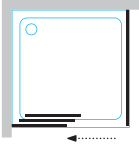

## TV3D/S + TSv3D 90, 80

- Freestanding shower cabin, threefold with shower wall.  
Optional K 30 profile for non-standard cabin widths.
- Selbständige Duschtür, dreiteilige mit der Duschwand.  
Zusätzliches K 30 Profil für nichtstandardmäßige Breiten von Kabinen als Option.
- Складные душевые двери, 3х-секционный с душевой стенкой. Возможность установки дополнительного профиля К 30 для установки душевых кабин нестандартных размеров по ширине.
- Önálló zuhanyajtó, háromrészes zuhanyfallal. Kiegészítő K 30-ós profil beépítésének lehetősége nem szabványos kabinszélességek esetében.

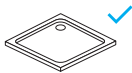
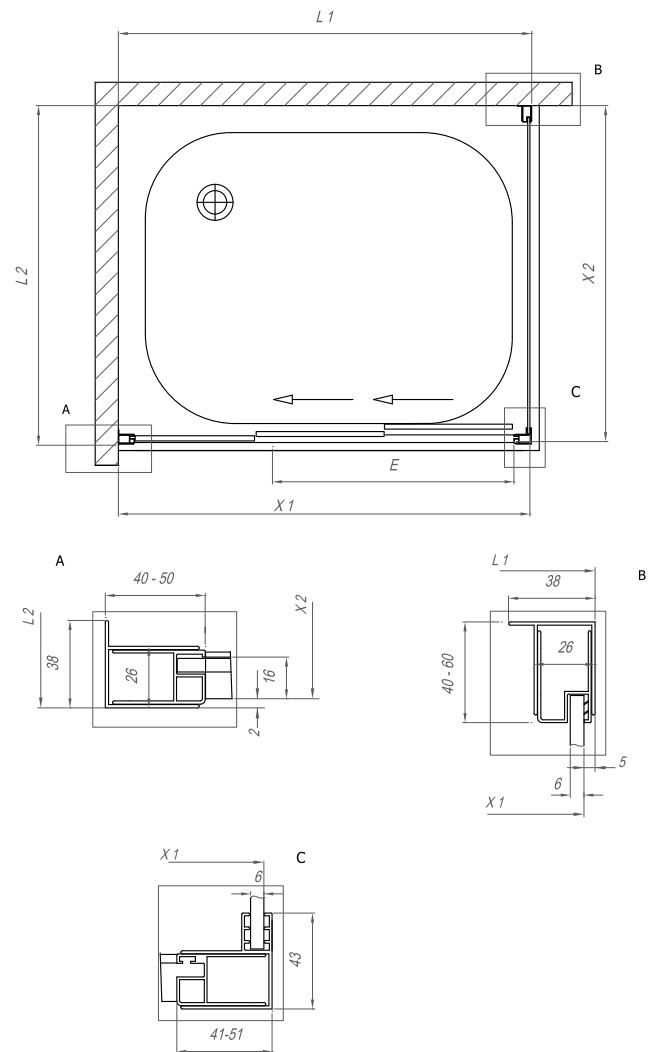

Tello, Lavolta, Lerock zero, Acro, Pandora Tray, Canary, Serra, Drop, Flamenco, Funky, Evelin Tray Q.

Luna			L1	L2	X1	X2		E		
TV3D/S 100			980 - 1000		975 - 995			1850	500	
TV3D/S 90			880 - 900		875 - 895			1850	430	
TV3D/S 80			780 - 800		775 - 795			1850	370	
TSv3D 90				875 - 895		873 - 893		1850		
TSv3D 80				775 - 795		773 - 793		1850		

# Luna TVZ/S 90, 80

208

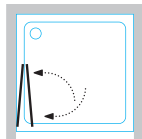

## TVZ/S 90, 80

- Freestanding shower door with foldable wings.  
Optional K 30 profile for non-standard cabin widths.
- Selbständige Duschtür mit faltbaren Flügeln.  
Zusätzliches K 30 Profil für nichtstandardmäßige Breiten von Kabinen als Option.
- Складные душевые двери. Возможность установки дополнительного профиля К 30 для установки душевых кабин нестандартных размеров по ширине.
- Önálló zuhanyajtó összerakható szárnyakkal. Kiegészítő K 30-ös profil beépítésének lehetősége nem szabványos kabinszélességek esetében.

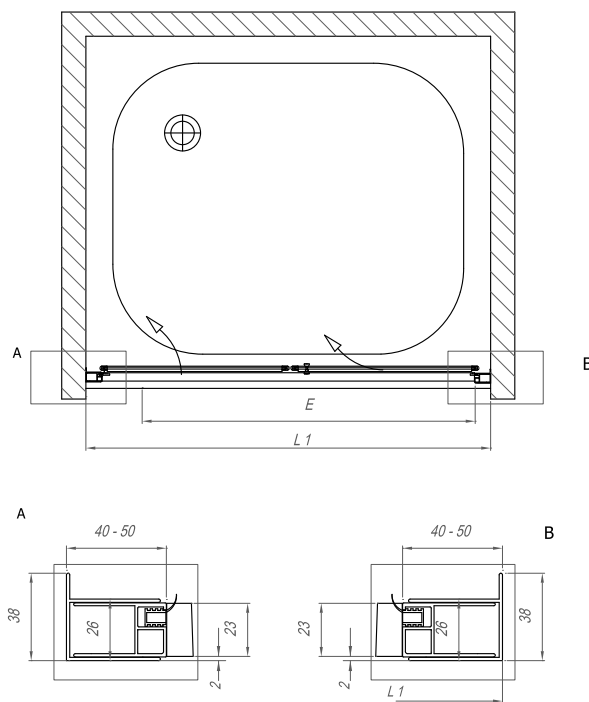

Luna TVZ/S 90, 80

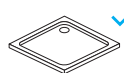

✓ Tello, Lavolta, Lerock zero, Pandora Tray, Canary, Serra, Drop, Flamenco, Evelin Tray Q, Trin.

Luna			L1	L2	X1	X2		E	
TVZ/S 90			880 - 900				1850	670	
TVZ/S 80			780 - 800				1850	570	



# Luna TVZ/S 90, 80 + TSvZ 90, 80

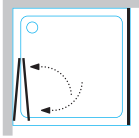

## TVZ/S 90, 80 + TSvZ 90, 80

- Freestanding shower door with foldable wings with shower wall.  
Optional K 30 profile for non-standard cabin widths.
- **Selbständige Duschtür mit faltbaren Flügeln mit der Duschwand.**  
Zusätzliches K 30 Profil für nichtstandardmäßige Breiten von Kabinen als Option.
- **Складные душевые двери с душевой стенкой.** Возможность установки дополнительного профиля К 30 для установки душевых кабин нестандартных размеров по ширине.
- **Önálló zuhanyajtó összerakható szárnyakkal zuhanyfallal.** Kiegészítő K 30-ös profil beépítésének lehetősége nem szabványos kabinszélességek esetében.

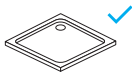
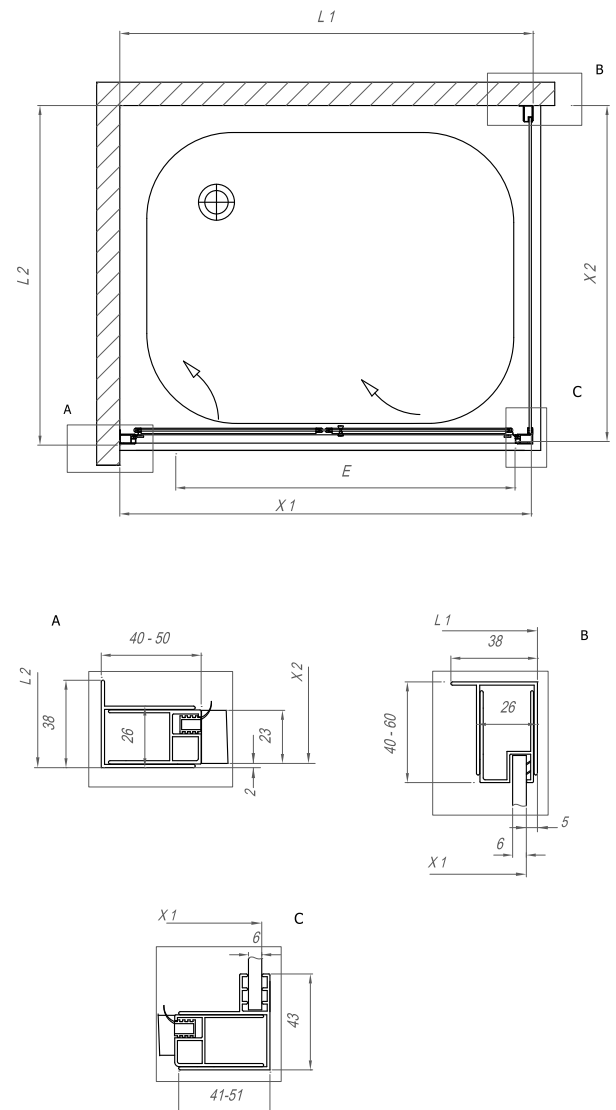

✓ Tello, Lavolta, Lerock zero, Pandora Tray, Canary, Serra, Drop, Flamenco, Evelin Tray Q, Trin.

Luna			L1	L2	X1	X2		E	
TVZ/S 90			880 - 900				1850	670	
TVZ/S 80			780 - 800				1850	570	
TSvZ 90				875 - 895		873 - 893	1850		
TSvZ 80				775 - 795		773 - 793	1850		

# Luna TVO/S 90, 80

210

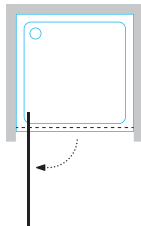

## TVO/S 90, 80

- **Shower cabin, turnable.**  
Optional K 25 profile for non-standard cabin widths.
- **Duschkabine, drehbar.**  
Zusätzliches K 25 Profil für nichtstandardmäßige Breiten von Kabinen als Option.
- **Душ кабина, вращающаяся.** Возможность установки дополнительного профиля К 25 для установки душевых кабин нестандартных размеров по ширине.
- **Zuhanykabin, forgatható.** Kiegészítő K 25-ös profil beépítésének lehetősége nem szabványos kabinszélességek esetében.

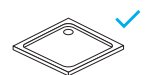
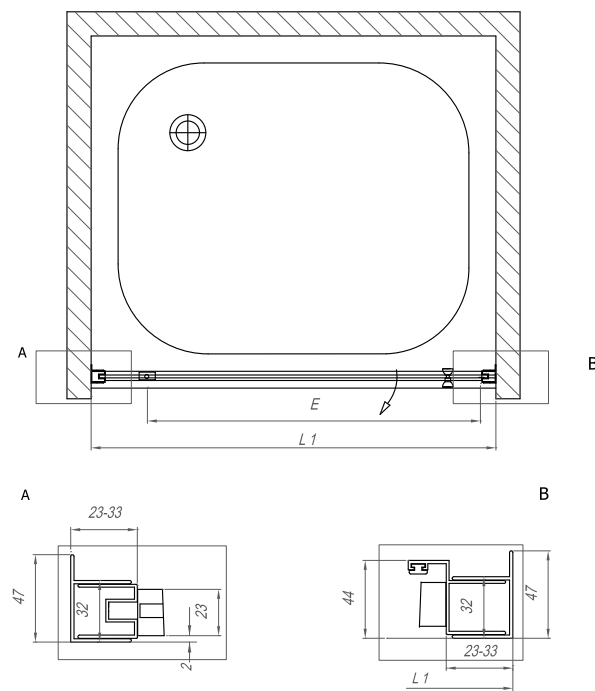

Tello, Lavolta, Lerock zero, Pandora Tray, Canary, Serra, Drop, Flamenco, Evelin Tray Q, Trin.

Luna			L1	L2	X1	X2		E	
TVO/S 90			880 - 900				1900	630	
TVO/S 80			780 - 800				1900	530	

**Additional profiles**

Zusätzliche Profile

Дополнительные профили

Dodatni profili

**Additional profiles for fitting nonstandard dimension enclosure widths.**

The variant with the compensational profile K 30 for TV3D/S, TVZ/S.

**Zusätzliches Profil für die Ausführung von nicht standardmäßigen Türbreiten.**

Variante mit Ausgleichsprofil K 30 für TV3D/S, TVZ/S.

**Дополнительный профиль для выполнения нестандартных размеров кабин по ширине.**

Вариант с компенсирующим профилем K 30 – для ТВ3Д/С, ТВЗ/С.

**A kiegészítő profilok a szabványon kívüli szélességű kabinok szereléséhez alkalmasak.**

Variáció K 30 toldóprofilal – TV3D/S, TVZ/S -nél.

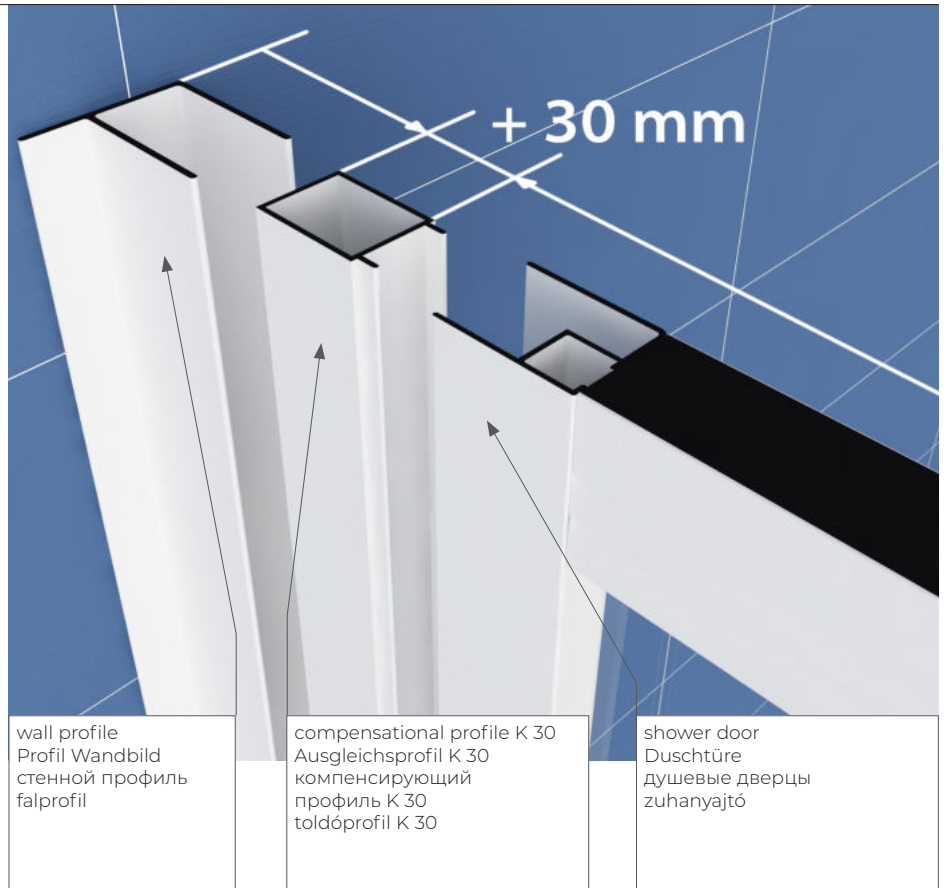

wall profile  
Profil Wandbild  
стенной профиль  
falprofil

compensational profile K 30  
Ausgleichsprofil K 30  
компенсирующий  
профиль K 30  
toldóprofil K 30

shower door  
Duschtüre  
душевые дверцы  
zuhanyajtó

**Additional profiles for fitting nonstandard dimension enclosure widths.**

The variant with the compensational profile K 25 for TVO/S.

**Zusätzliches Profil für die Ausführung von nicht standardmäßigen Türbreiten.**

Variante mit Ausgleichsprofil K 25 für TVO/S.

**Дополнительный профиль для выполнения нестандартных размеров кабин по ширине.**

Вариант с компенсирующим профилем K 25 – для ТВО/С

**A kiegészítő profilok a szabványon kívüli szélességű kabinok szereléséhez alkalmasak.**

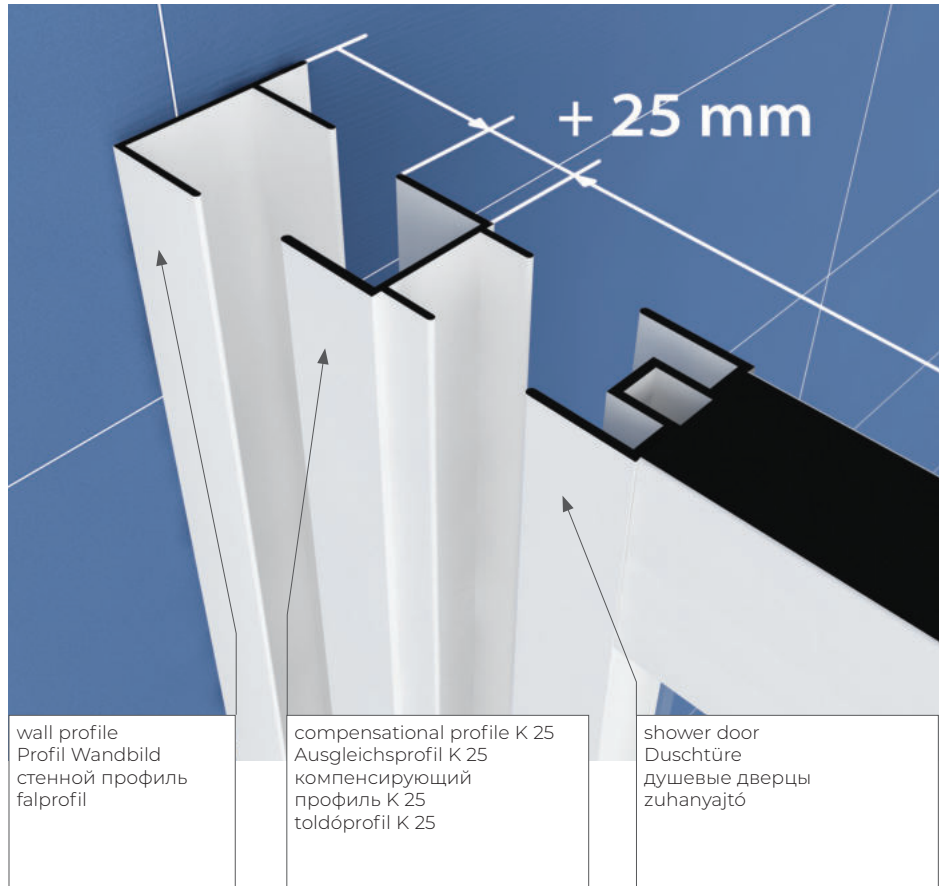

Variáció K 25 toldóprofilal – TVO/S -nél.



wall profile  
Profil Wandbild  
стенной профиль  
falprofil

compensational profile K 25  
Ausgleichsprofil K 25  
компенсирующий  
профиль K 25  
toldóprofil K 25

shower door  
Duschtüre  
душевые дверцы  
zuhanyajtó

Type/Тур/Тип/ Típus	Type of profile / Profiltyp / Вид профиля / Profiltípus		
K 30 - TV3D/S, TVZ/S	additional profile for TV3D/S, TVZ/S / Zusätzliches Profil für TV3D/S, TVZ/S / дополнительный профиль для ТВ3Д/С, ТВЗ/С / kiegészítő profil TV3D/S, TVZ/S típushoz	1850	30
K 25 - TVO/S	additional profile for TVO/S / Zusätzliches Profil für TVO/S / дополнительный профиль для ТВО/С / kiegészítő profil TVO/S típushoz	1900	25





Eco Quat

# ECO QUAT

	<p><b>5 mm transparent tempered glass</b>          5 mm transparentes gehärtetes Glas          5 мм прозрачное закаленное стекло          5 mm átlátszó edzett üveg</p>		
5 mm	<p><b>BLACK profiles, powder coating</b>          BLACK (schwarze) Profile, staublackiert          BLACK (черные) профили, порошковое покрытие лаком          BLACK (fekete) profilok, porlakkozás</p>		
2000 mm	<p><b>Silver Studs (polished silver galvanised coating)</b>          Silber Profile (polierte silberne galvanische Beschichtung)          Серебряные шпильки (полированное серебряное гальваническое покрытие)          Ezüst profilok (ezüst horganyzott bevonat)</p>		
1850 mm	<p><b>magnetic edge closure</b>          Magnetprofil-Verschluss          закрытие с магнитным профилем          zárás mágneses profilal</p>		
	<p><b>detachable door panels for easy cleaning</b>          abnehmbare Türen ermöglichen einfachere Reinigung          съемные двери, позволяющие легкую очистку          a könnyen leemelhető ajtószárnyak könnyed tisztítást tesznek lehetővé</p>		

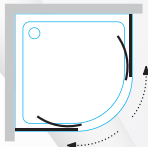
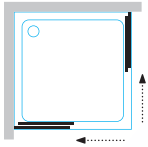

# Eco Quat TTK 90, 80

214

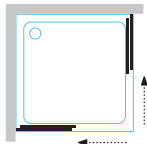

## TKK 90, 80

- Corner shower enclosure. Door panels on ball bearings, detachable for easier cleaning.
- Eckeinstieg 2-teilig mit Gleittüren. Für einfachere Reinigung können die Türflügel herausgenommen werden.
- Угловая душевая кабина. Съёмные дверные части на шариковых подшипниках, которые позволяют лёгкую очистку.
- Szögletes zuhanykabin. Levehető ajtószárnyak golyóscsapágyakon, amelyek könnyebb tisztítást tesznek lehetővé.

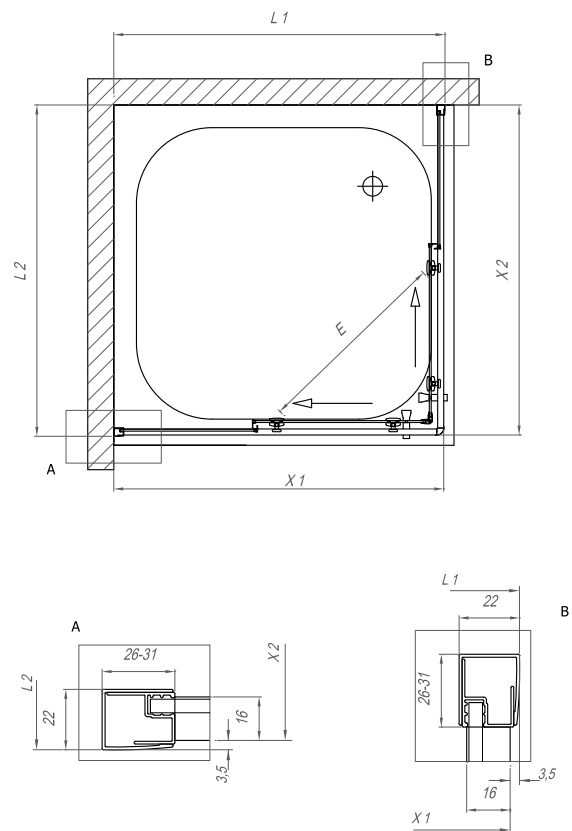

Eco Quat TTK 90, 80

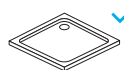

Tello, Lavolta, Lerock zero, Pandora Tray, Canary, Serra, Drop, Flamenco, Evelin Tray Q, Trin.

Eco Quat			L1	L2	X1	X2		E	
TKK 90			875 - 880	875 - 880	872 - 877	872 - 877	1850	495	
TKK 80			775 - 780	775 - 780	772 - 777	772 - 777	1850	432	

# Eco Quat TKP 90, 80

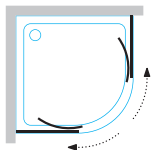

## TKP 90, 80

- Semi-circular shower enclosure. Door panels on ball bearings, detachable for easier cleaning.
- Viertelkreis- Duschkabine mit Gleittüren. Für einfachere Reinigung können die Türflügel herausgenommen werden.
- Полукруглая душевая кабина. Съёмные дверные части на шариковых подшипниках, которые позволяют лёгкую очистку.
- Félköríves zuhanykabin. Levehető ajtószárnyak golyóscsapágyakon, amelyek könnyebb tisztítást tesznek lehetővé.

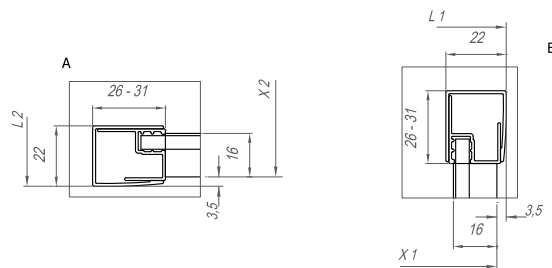
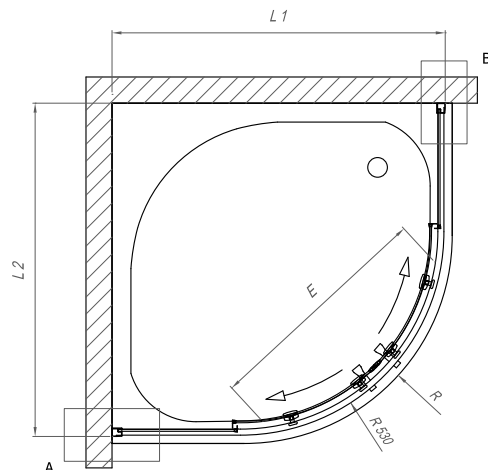

Lavolta R, Moonwalk R, Macarena, Drop R, Malur, Dixie, Evelin Tray R, Ontex.

Eco Quat			L1	L2	X1	X2			E	
TKP 90			875 - 880	875 - 880	872 - 877	872 - 877	550	1850	570	
TKP 80			775 - 780	775 - 780	772 - 777	772 - 777	550	1850	450	

216



Polaris

# POLARIS



	<p><b>8 mm transparent tempered glass</b>        8 mm transparentes gehärtetes Glas        8 мм прозрачное закаленное стекло        8 mm átlátszó edzett üveg</p>	 
8 mm	<p><b>Silver Brill Studs (high gloss-polished silver galvanised coating)</b>        Silver Brill profíli (visokopolirana srebrna galvanska prevlaka)        Серебристые профили бриллиант (серебряное гальваническое покрытие высококачественной полировки)        Ezüst Brill profílok (magas fényezésű ezüst galvanizált burkolat)</p>	 
1400 mm	<p><b>BLACK profiles, powder coating</b>        BLACK (schwarze) Profile, staublackiert        BLACK (черные) профили, порошковое покрытие лаком        BLACK (fekete) profílok, porlakkozás</p>	 
1400 mm	<p><b>glass stabilization support</b>        Stütze für die Glasstabilisierung        поддержка для стабилизации стекла        támaszték az üveg stabilizálásához</p>	
	<p><b>Clean coat, protective coating</b>        Clean coat, Schutzbeschichtung        Clean coat защитное покрытие        Clean coat, védőbevonat</p>	

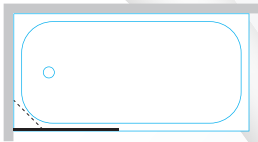

# Polaris BS 80 UNI 1

218

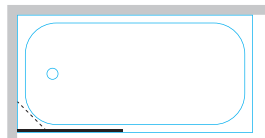

Glass support for BS 80 UNI 1  
 Glasstütze für BS 80 UNI 1  
 Опора стекла для BS 80 UNI 1  
 Üvegfal támasz BS 80 UNI 1

## BS 80 UNI 1

- One-piece screen for bathtubs. Left- and right-hand installation options. Suitable for all lengths of bathtubs.
- Einteiliger Pendelflügel für Badewanne. Einbauoptionen links und rechts. Die Wand ist für Duschwannenmodelle aller Längen geeignet.
- 1-секционный душевой заслон для ванн. Возможность монтажа слева или справа. Душевой заслон подходит для ванн всех длин.
- Egyoldalú kádpáraván fürdőkádakhoz. Bal- vagy jobb beépítési lehetőség. A paraván minden méretű fürdőkádra szerelhető.

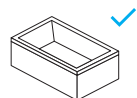
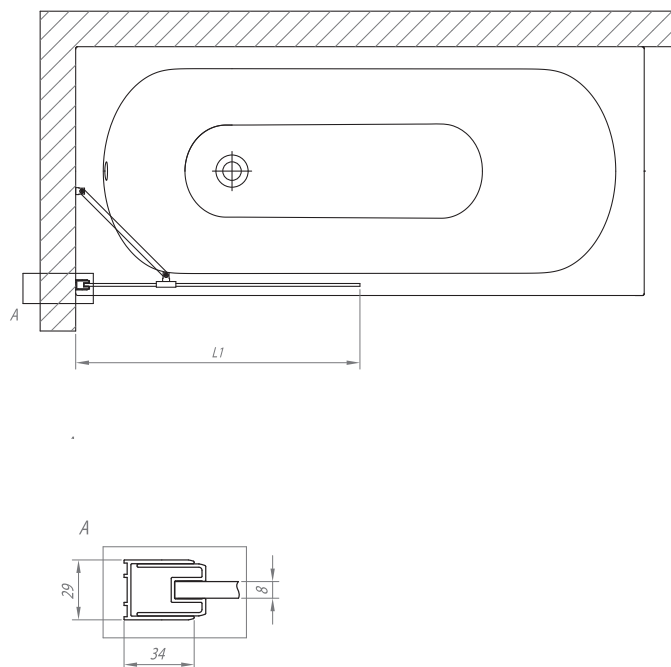
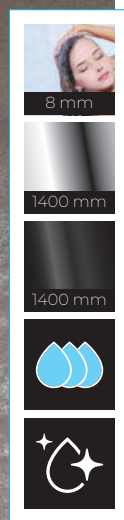

Polaris BS 80 UNI 1

Polaris

BS 80 UNI 1



L1

800

L2

X1

X2

1400

E





220



Andromeda

# ANDROMEDA

	<p><b>8/6 mm transparent tempered glass</b>                  8/6 mm transparentes gehärtetes Glas                  8/6 мм прозрачное закаленное стекло                  8/6 mm átlátszó edzett üveg</p>	 
<p>8/6 mm</p>	<p><b>Silver Brill Studs (high gloss-polished silver galvanised coating)</b>                  Silver Brill profili (visokopolirana srebrna galvaniska prevlaka)                  Серебристые профили бриллиант (серебряное гальваническое покрытие высококачественной полировки)                  Ezüst Brill profilok (magas fényezésű ezüst galvanizált burkolat)</p>	  <p>SBR</p>
<p>1400 mm</p>	<p><b>BLACK profiles, powder coating</b>                  BLACK (schwarze) Profile, staublackiert                  BLACK (черные) профили, порошковое покрытие лаком                  BLACK (fekete) profilok, porlakkozás</p>	  <p>B</p>
<p>1400 mm</p>	<p><b>glass stabilization support</b>                  Stütze für die Glasstabilisierung                  поддержка для стабилизации стекла                  támaszték az üveg stabilizálásához</p>	
<p>1400 mm</p>	<p><b>Clean coat, protective coating</b>                  Clean coat, Schutzbeschichtung                  Clean coat защитное покрытие                  Clean coat, védőbevonat</p>	
	<p><b>glass stabilization support</b>                  Stütze für die Glasstabilisierung                  поддержка для стабилизации стекла                  támaszték az üveg stabilizálásához</p>	
	<p><b>Clean coat, protective coating</b>                  Clean coat, Schutzbeschichtung                  Clean coat защитное покрытие                  Clean coat, védőbevonat</p>	

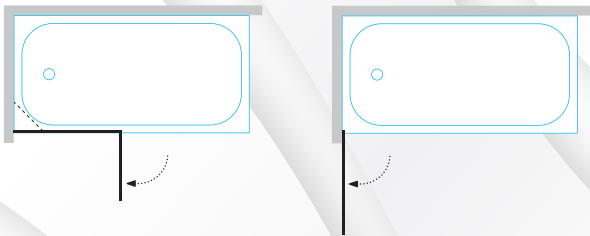

# Andromeda BS 120 UNI 1-2P

222

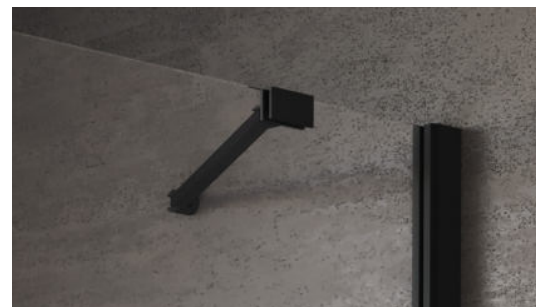
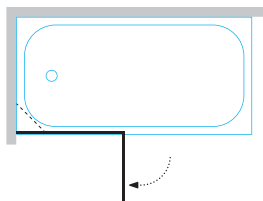

## BS 120 UNI 1-2P

- Two-piece screen for bathtubs fixed on outer profile hinges. Left- and right-hand installation options. Suitable for all lengths of bathtubs.
- Zweiteilige Pendelflügel für Badewanne. Einbauoptionen links und rechts. Die Wand ist für Duschwanne-Modelle aller Längen geeignet.
- 2-секционный душевой заслон для ванн. Возможность монтажа слева или справа. Душевой заслон подходит для ванн всех длин.
- Kétrészes kádparaván fürdőkádakhoz forgatható profillal. Bal- vagy jobb beépítési lehetőség. A paraván minden méretű fürdőkádra szerelhető.

Glass support for BS 120 UNI 1-2P  
 Glasstütze für BS 120 UNI 1-2P  
 Опора стекла для BS 120 UNI 1-2P  
 Üvegfal támasz BS 120 UNI 1-2P

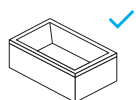
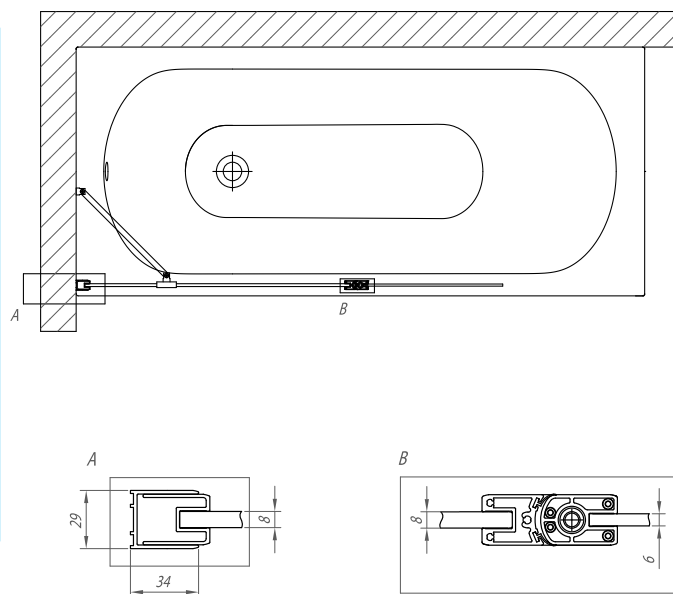
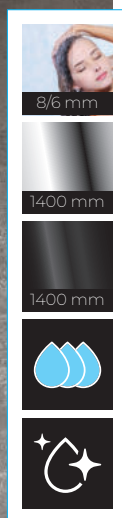

Andromeda BS 120 UNI 1-2P

Andromeda  
 BS 120 UNI 1-2P



L1  
 1200

L2  
 1400

X1

X2

E



# Andromeda BS 80 UNI 1-1P

223

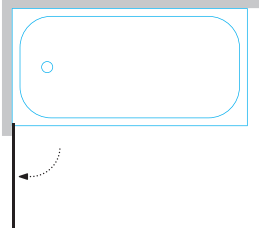

## BS 80 UNI 1-1P

- One-piece screen for bathtubs fixed on outer profile hinges. Left- and right-hand installation options. Suitable for all lengths of bathtubs.
- Einteilige Pendelflügel für Badewanne. Einbauoptionen links und rechts. Die Wand ist für Duschwannenmodelle aller Längen geeignet.
- 1-секционный душевой заслон для ванн. Возможность монтажа слева или справа. Душевой заслон подходит для ванн всех длин.
- Egyoldalú kádparaván fürdőkádakhoz forgatható profillal. Bal- vagy jobb beépítési lehetőség. A paraván minden méretű fürdőkádra szerelhető.

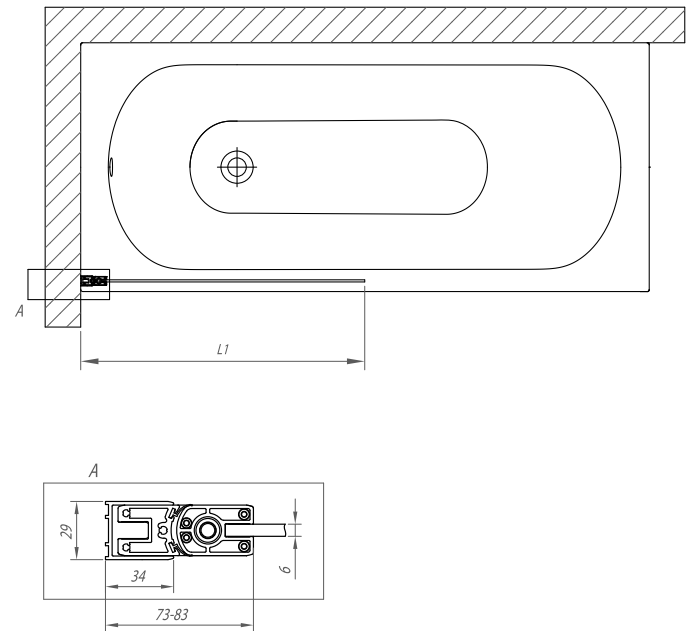

Andromeda BS 80 UNI 1-1P

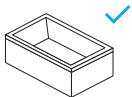

Andromeda  
BS 80 UNI 1-2P



L1  
800

L2  
800

X1  
800

X2  
800

E  
1400



224



Sole

# SOLE





6 mm

**6 mm transparent tempered glass**  
 6 mm transparentes gehärtetes Glas  
 6 мм прозрачное закаленное стекло  
 6 mm átlátszó edzett üveg



1400 mm

**Silver Studs (polished silver galvanised coating)**  
 Silber Profile (polierte silberne galvanische Beschichtung)  
 Серебряные шпильки (полированное серебряное гальваническое покрытие)  
 Ezüst profilok (ezüst horganyzott bevonat)



**Chromium-plated (10x15, length=52cm) support to stabilize glass for: a: TP 102, TP 104**  
 Chromstütze (10x15, Länge=52cm) für die Glasstabilisierung für: TP 75, TP 102, TP 104, TP 112, TP 123  
 Хромированная опора (10x15, длина=52см) для стабилизации стекла: TP 102, TP 104  
 Krómozott támasztóelem (10x15, hossz=52cm) az üveg stabilizációjához: TP 102, TP 104

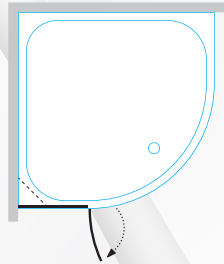
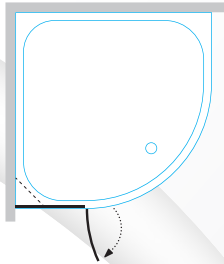

# Sole TP 102 UNI

226

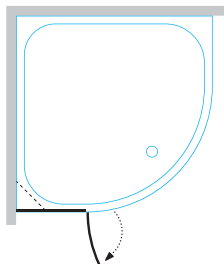

Glass support for TP (tp 102,104)  
 Glasstütze für TP (tp 102,104)  
 Опора стекла для TP (tp 102,104)  
 Üvegfal támasz TP (tp 102,104)

## TP 102 UNI

• Two-piece screen for bathtubs fixed on outer wall profile hinges.

One of the hinged wings can be opened outwards, while both folded together can be opened to either side.

• **Zweiteilige Pendelflügel für Badewanne.** Einer von den beiden Flügeln kann mittels Scharnieren nach außen geöffnet werden, zusammengeklappt können sie zu jeder Seite geöffnet werden.

• **2-секционный душевой заслон для ванн.** Первая секция установлена на шарнирах, переключаемая на внешнюю сторону, обе секции складываются внутрь или наружу.

• **Kétrészes kádpáraván fürdőkádákhoz forgatható falprofilal.** A paraván sarokkádakra szerelhető. Az első szárny zsanérokon elfordítható a külső oldalra, Mindkét szárny össze-csukható a belső vagy a külső oldalra.

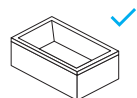
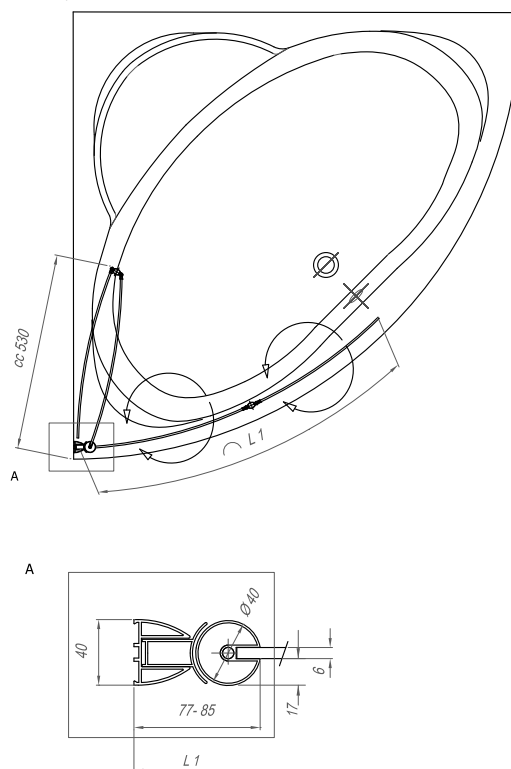

# Sole TP 104 UNI

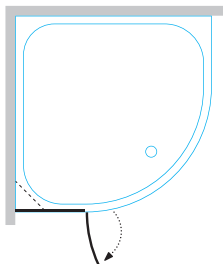

Glass support for TP (tp 102,104)  
 Glasstütze für TP (tp 102,104)  
 Опора стекла для TP (tp 102,104)  
 Üvegfal támasz TP (tp 102,104)

## TP 104 UNI

- Two-piece screen for bathtubs fixed on outer wall profile hinges.

One of the hinged wings can be opened outwards, while both folded together can be opened to either side.

- **Zweiteilige Pendelflügel für Badewanne.** Einer von den beiden Flügeln kann mittels Scharnieren nach außen geöffnet werden, zusammengeklappt können sie zu jeder Seite geöffnet werden.
- **2-секционный душевой заслон для ванн.** Первая секция установлена на шарнирах, переключаемая на внешнюю сторону, обе секции складываются внутрь или наружу.
- **Kétrészes kádparaván fürdőkádakhoz forgatható falprofilal.** A paraván sarokkádakra szerelhető. Az első szárny zsanérokön elfordítható a külső oldalra, Mindkét szárny össze-csukható a belső vagy a külső oldalra.

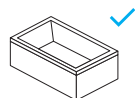
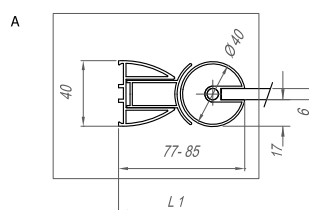
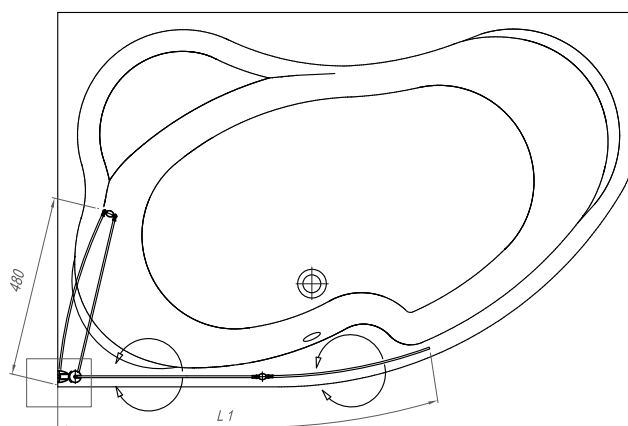

228











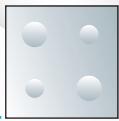

1400 mm

2 mm

Quat

# QUAT

 <p><b>5 mm</b></p>	<p><b>5 mm transparent tempered glass</b>                  5 mm transparentes gehärtetes Glas                  5 мм прозрачное закаленное стекло                  5 mm átlátszó edzett üveg</p>	 
 <p><b>2 mm</b></p>	<p><b>2 mm Quat polystyrene glass</b>                  2 mm Polystyrolglas Quat                  2 мм полистрол стекло Quat                  2 mm Quat polisztiiren üveg</p>	 
 <p><b>1400 mm</b></p>	<p><b>Silver Studs (polished silver galvanised coating)</b>                  Silber Profile (polierte silberne galvanische Beschichtung)                  Серебряные шпильки (полированное серебряное гальваническое покрытие)                  Ezüst profilok (ezüst horganyzott bevonat)</p>	 
 <p><b>1400 mm</b></p>	<p><b>White Studs (powder coating)</b>                  Weiße Profile (Pulverbeschichtung)                  Белый профиль (порошковое покрытие)                  Fehér profilok (porlakkozás)</p>	 

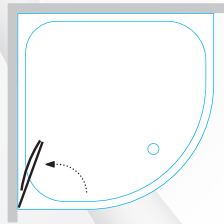
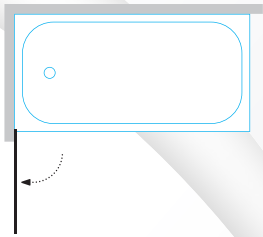

# Quat TP 80 UNI

230

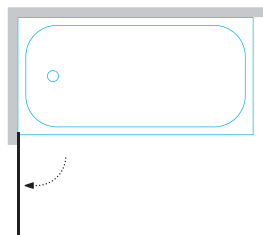

## TP 80 UNI

- One-piece screen for bathtubs fixed on outer wall profile hinges. Left- and right-hand installation options. Suitable for all lengths of bathtubs.
- Einteiliger Pendelflügel für Badewanne. Einbauoptionen links und rechts. Die Wand ist für Duschwanne Modelle aller Längen geeignet.
- 1-секционный душевой заслон для ванн. Возможность монтажа слева или справа. Душевой заслон подходит для ванн всех длин.
- Egyoldalú kádpáraván fürdőkádakhoz forgatható falprofilal. Bal- vagy jobb beépítési lehetőség. A paraván minden méretű fürdőkádra szerelhető.



5 mm

1400 mm

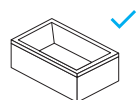
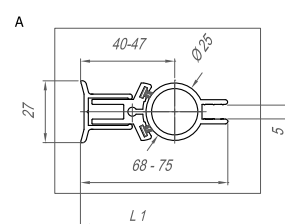
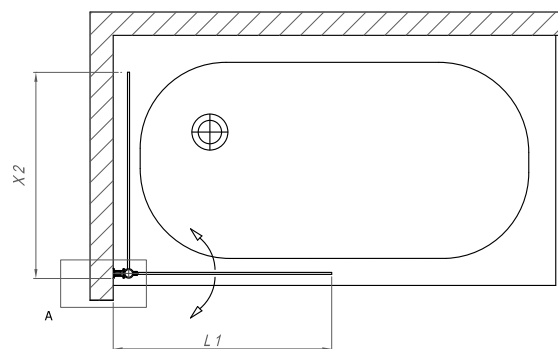

Quat

TP 80 UNI



800



L2



X1



X2



1400



E



E

# Quat TP 105, 108 UNI

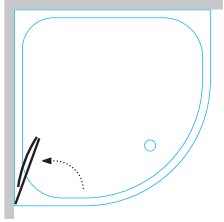

## TP 105, 108 UNI

- Foldable two-piece screen for corner shower cabins.. Left- and right-hand installation options.
- Zweiteilige faltbare Duschwand für Eckbadewannen. Einbauoptionen links und rechts.
- Складная двойная перегородка для угловых ванн. Могут быть установлены с правой или с левой стороны ванны.
- Harmonika rendszerű kétrészes kádpáraván, sarokkádkakhoz. Bal, illetve jobboldali szerelési lehetőség.

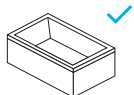
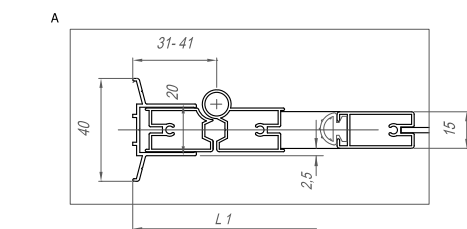
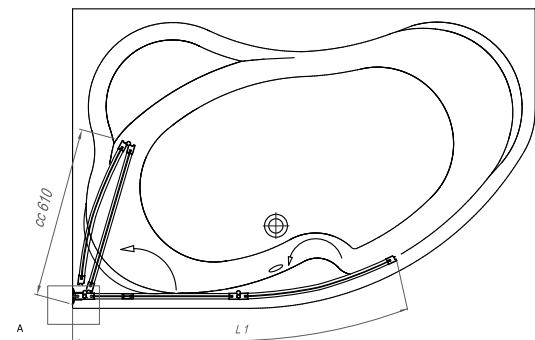
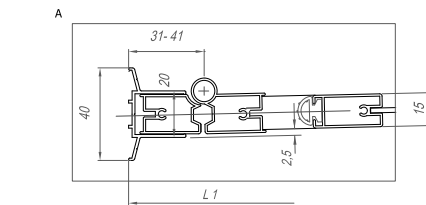
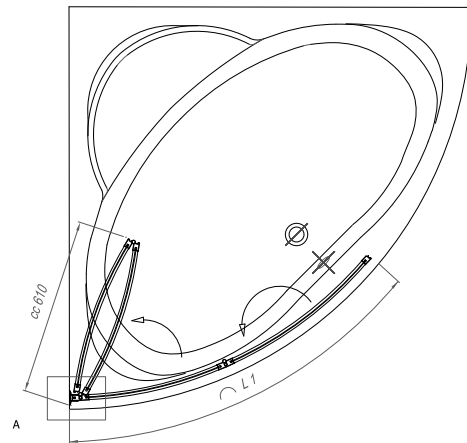

Quat			L1	L2	X1	X2		E	
TP 105 UNI			1050				1400		
TP 108 UNI			1080				1400		





## Additional profiles for shower enclosures

Zusätzliche Profile für Duschkabinen

Дополнительные профили в душевых кабинах

Kiegészítő profilok zuhanykabinokhoz



The dimensions of my bathroom are non-standard. What now?

Die Abmessungen meinem Badezimmer sind nicht-Standard. Was nun?

Что делать, если у меня ванная комната нестандартных размеров?

Szokatlan fürdőszobaméretekkkel rendelkezem. Mitevő legyek?

For the situations where the space available for the installation of a shower cabin/enclosure is of non-standard size, we have designed additional compensation studs allowing adjusting standard products to the desired dimensions. Check the following pages for products offering this option.

Für die Fälle, wenn der Platz, vorhanden für den Einbau der Duschkabine nicht den Standardabmessungen entspricht, haben wir zusätzliche Kompensationsprofile entwickelt, mit welchen die Standardprodukte an die gewünschten Maße angepasst werden können. Auf den folgenden Seiten zeigen wir Ihnen die Produkte, die diese Option anbieten.

Для случаев, когда место установки душевой кабины нестандартных размеров, мы разработали дополнительные профили, с помощью которых стандартные изделия можно приспособить к желаемым меркам. На следующих страницах можно просмотреть изделия, подходящие для этой опции.

Azokra az esetekre, amikor a zuhanykád beépítésére nem standard méretű hely marad, kiegészítő, ún. kompenzációs profilokat fejlesztettünk. Ezek segítségével a standard méretű termékeket kívánt méretre lehet alakítani. Az alábbi oldalakon ellenőrizheti, mely termékek esetében lehetséges ez a megoldás.

Example of using an additional profile

Beispiel der Verwendung eines zusätzlichen Profils

Пример использования дополнительного профиля

Kiegészítő profil használati példája

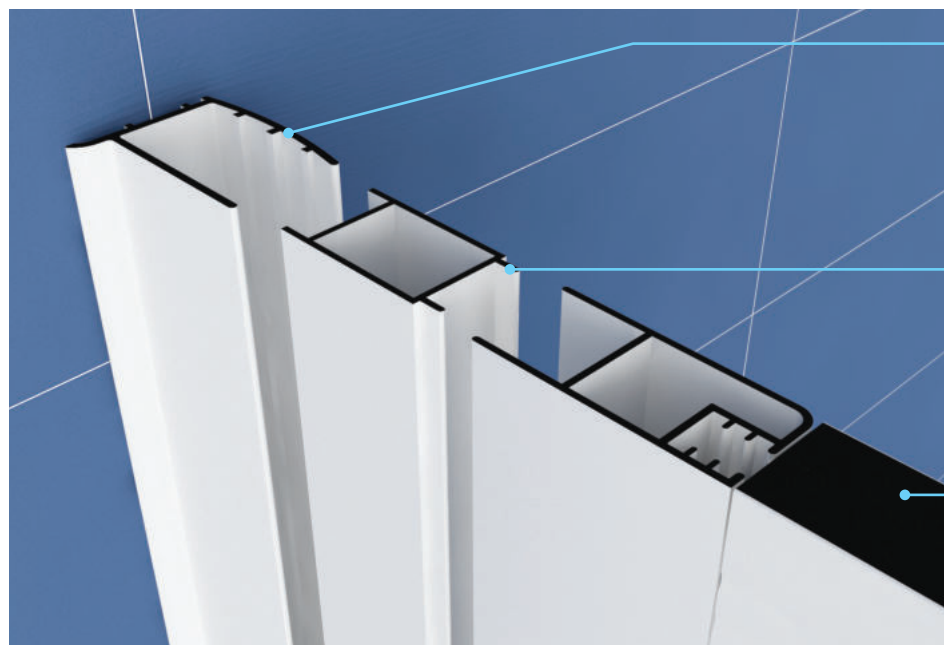

wall profile  
Wandprofil  
профиль настенный  
falprofil

additional compensation profile  
Zusätzliches Ausgleichprofil  
дополнительный компенсационный профиль  
kiegészítő kompenzációs profil

shower enclosures  
Duschtür  
душевые дверцы  
zuhanyajtó





## Shower cabins with special dimensions

Duschkabinen mit Sondermassen  
 Душевые кабины особых размеров  
 Különleges méretű zuhanyfülkék

233



What if I don't find a solution for my shower enclosure in your regular programme?  
 Was passiert wenn das Badezimmerprogramm keine Lösung für meine Dusche bietet?  
 Что делать, если в обычной программе нет решений для моей душевой кабины?  
 Mi történik, ha a rendszeres kínálatban nem létezik megoldás számomra?

In case our standard solutions of shower cabins/enclosures fail to meet your requirements, we can design a tailor-made solution for you. For more information on non-standard shower cabins/enclosures, visit our [www.kolpa.si](http://www.kolpa.si) website.

Falls unsere Standardlösungen für Duschkabinen Ihren Bedürfnissen ungeeignet sind, stellen wir Ihnen die entsprechenden Lösungen nach Maß gerne bereit. Für weitere Informationen über Duschkabinen mit Sonderabmessungen besuchen Sie bitte unsere Internetseite [www.kolpa.si](http://www.kolpa.si).

В случае, если стандартные размеры душевых кабин Вам не подходят, то мы можем сделать душевую кабину размером, который Вам будет приемлем. Для получения дополнительной информации, касающейся душевых кабин нестандартных размеров, посетите наш сайт [www.kolpa.si](http://www.kolpa.si).

Amennyiben a standard méretű zuhanykabinok nem megfelelőek számára, méretre is el tudjuk készíteni. A különleges méretű zuhanykabinokról több adatot talál a [www.kolpa.si](http://www.kolpa.si) weblapon. nu [www.kolpa.si](http://www.kolpa.si).



Height adjustment option  
 Höhe-Anpassungsoption  
 Возможность регулировки высоты  
 Magasság megváltoztatásának lehetősége



Width adjustment option  
 Breite-Anpassungsoption  
 Возможность регулировки ширины  
 Szélesség megváltoztatásának lehetősége



Angle adjustment option  
 Winkel-Anpassungsoption  
 Возможность регулировки угла наклона  
 Dőlésszög megváltoztatásának lehetősége



Shape adjustment option  
 Formen-Anpassungsoption  
 Возможность корректировки формы  
 Forma megváltoztatásának lehetősége



Stud colour options  
 Profilarbenauswahlmöglichkeit  
 Возможность выбора цвета профиля  
 Profilszín kiválasztásának lehetősége



Info

When no suitable solution for complex shower cabins can be found in this catalogue, we'll be happy to fix an individual solution for you.  
 Wenn keine geeignete Lösung für komplexe Duschkabinen in diesem Katalog vorhanden ist, finden wir gerne eine individuelle Lösung für Sie.  
 Если особо требовательный покупатель не найдет подходящего решения в данном предложении, то в таких случаях мы можем подобрать индивидуальное решение проблемы заказчика.  
 A kínálatban található igen igényes zuhanykád esetekre a vendők számára egyedi megoldásokat készíthetünk.



## RE WALL-Universal Kerrock wall

RE WALL-Universelle Kerrock-Wand  
RE WALL-Универсальная стенка Kerrock  
RE WALL-Univerzális Kerrock fal

234

Tools, preparation and measurements  
Handwerkzeug, Vorbereitung und Messungen  
Инструменты, подготовка и измерения  
Eszközök, előkészítés és mérések

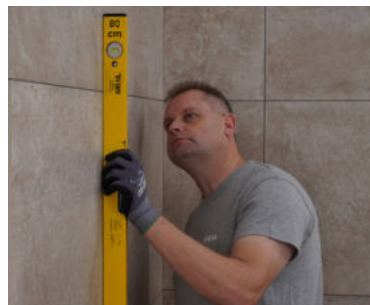
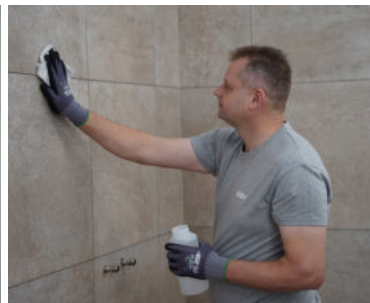

Drilling the tap hole and setting the left wall

Bohren des Wasserhahnlochs und Aufstellen der linken Wand

Сверление отверстия для крана и установка левой стены

Csapfurat fúrása és a bal oldali fal felszerelése

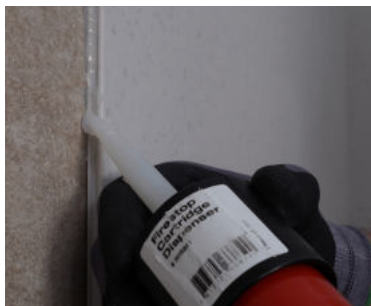
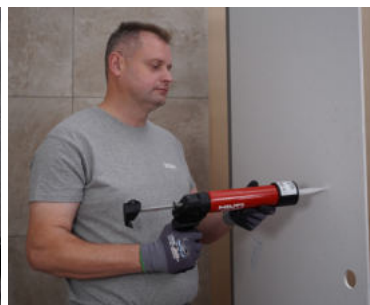

Info

Right wall layout  
Aufstellen der rechten Wand  
Установка правой стены  
A jobb oldali fal felszerelése

Installation of shower enclosure with additional support  
Einbau der Duschkabine mit zusätzlicher Stütze  
Установка душевой кабины с дополнительной опорой  
Zuhanyfülkék szerelése kiegészítő támasztékkal

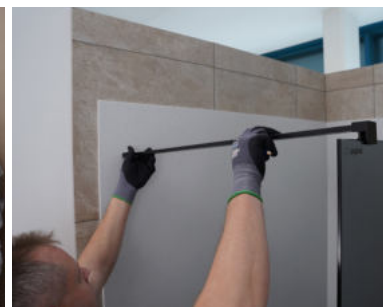
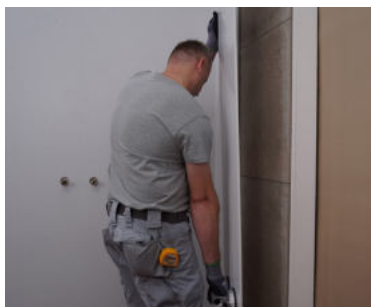



**RE WALL-Universal Kerrock wall**  
 RE WALL-Universelle Kerrock-Wand  
 RE WALL-Универсальная стенка Kerrock  
 RE WALL-Univerzális Kerrock fal

235



Re-Wall  
 80x80, 90x90, 100x100,  
 120x80, 120x90,  
 140x80, 140x90,  
 160x80, 160x90  
 H = 2200mm

**kerrock®**  
 BY KOLPASAN



109 - White

9252 - Andesite

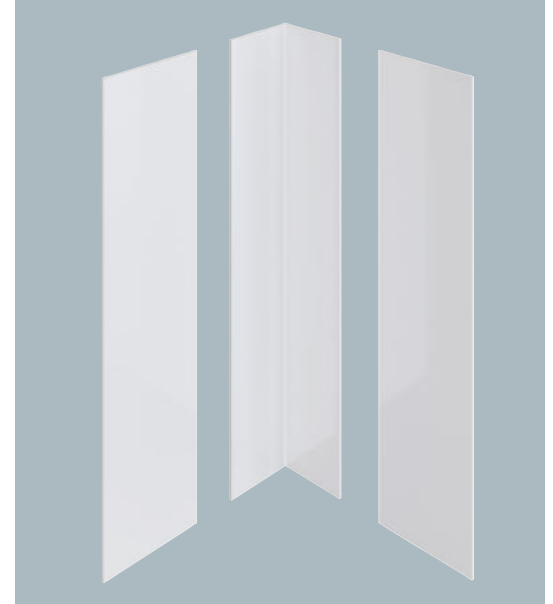

Three-piece element-disassembly  
 Dreiteiliges Element-abnehmbar  
 Трехкомпонентный элемент – разборка  
 Háromrészes elem – leszerelhető



Info