



CUBUS
shelf system

REŠITEV V VEČ POGLEDIH

*RAZLIČNI TIPI KUBUSOV
POLJUBNO ŠTEVILO HORIZONTALNIH IN VERTIKALNIH ODDELKOV
VEČ MOŽNOSTI ZA DOLŽINO, VIŠINO IN GLOBO KUBUSNEGA PROFILA
(STANDARDNE IN NESTANDARDNE DIMENZIJE)
VISEČI ALI SAMOSTOJEČI KUBUS
KUBUS Z ALI BREZ DRSNIH VRAT
RAZLIČNE VRSTE POLIC MED NIVOJI (LES ALI STEKLO)*

MULTILEVEL SOLUTION

*DIFFERENT CUBUS TYPES
OPTIONAL NUMBER OF HORIZONTAL AND VERTICAL COMPARTMENTS
MORE OPTIONS FOR LENGTH, HEIGHT AND DEPTH OF THE CUBUS
PROFILE (STANDARD AND NON-STANDARD DIMENSIONS)
HANGING OR SELF STANDING
WITH OR WITHOUT SLIDING DOORS
DIFFERENT SHELF TYPES BETWEEN CUBUS LEVELS (WOOD OR GLASS)*

info@rujzdesign.com

www.rujzdesign.com

CUBUS SHELF SYSTEM BY RUJZ DESIGN



cb61.01/1x1/...



LESENA ALI STEKLENA POLICA / WOODEN OR GLASS SHELF
VISEČI ALI SAMOSTOJEČI / HANGING OR SELF STANDING



CB61.01/1X1/WW/390X350X900/H



CB61.01/1X1/GW/390X350X900/H

Z DRSNIMI VRATI ALI BREZ
WITH SLIDING DOORS



CB61.02/1X1/WW/390X350X900/H

* Lx, Wx, Hx;

Dolžina, širina ali višina cubusa, ki ni natančno določena predstavlja nestandardne dimenzije, ki so dobavljive po naročilu.

Length, Width and Height that are not precisely defined represent non-standard dimensions and are available on request.

* Prikazani leseni ali stekleni deli cubusa niso v sklopu dobave saj gre le za prikaz uporabe.

Wooden or glass parts shown are not within a scope of the supply, it is merely a demonstration of use.

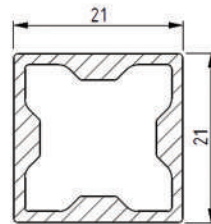
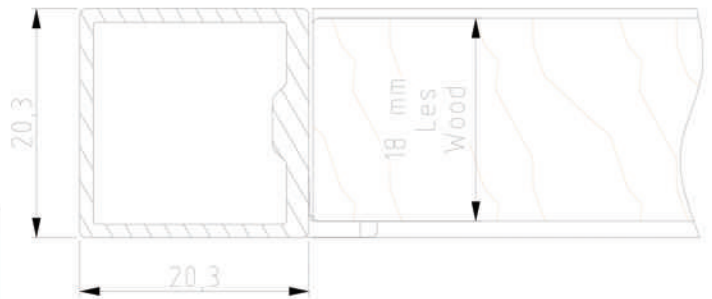
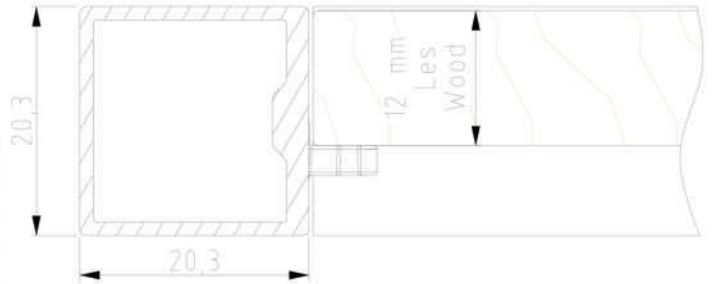
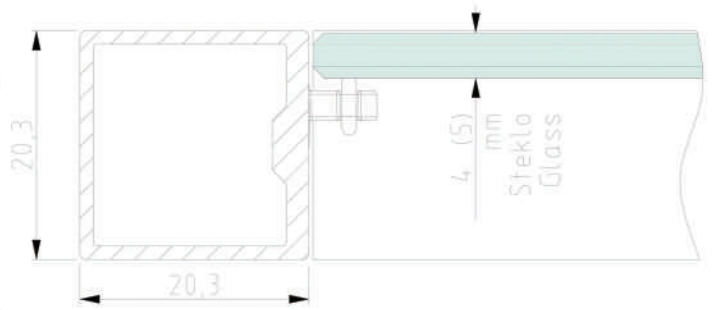

Vertikalni profil
Vertical profile

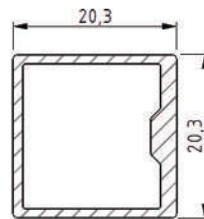

Horizontalni profil
Horizontal profile

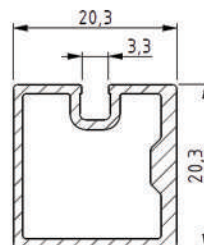

Profil za drsna vrata
Sliding door profile



Stenski nivelator
Wall leveler



Nivelirna nogica
Leveling foot

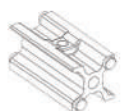

Vezni element
Connecting piece



Plastični pokrov
Plastic cover

PROFILI / PROFILES

VEZNI ELEMENTI
MOUNTING COMPONENTS

SHELF HOLDERS



Nosilec steklene police 4 (5) mm
Holder for glass shelf 4 (5) mm

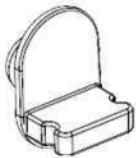

Nosilec lesene police 12 mm
Holder for wooden shelf 12 mm

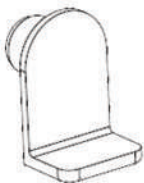

Nosilec lesene police 18 (19) mm
Holder for wooden shelf 18 (19) mm

SESTAVLJEN CUBUS 2X1 / COMPOUND CUBUS 2X1

CB61.02/2x1/...

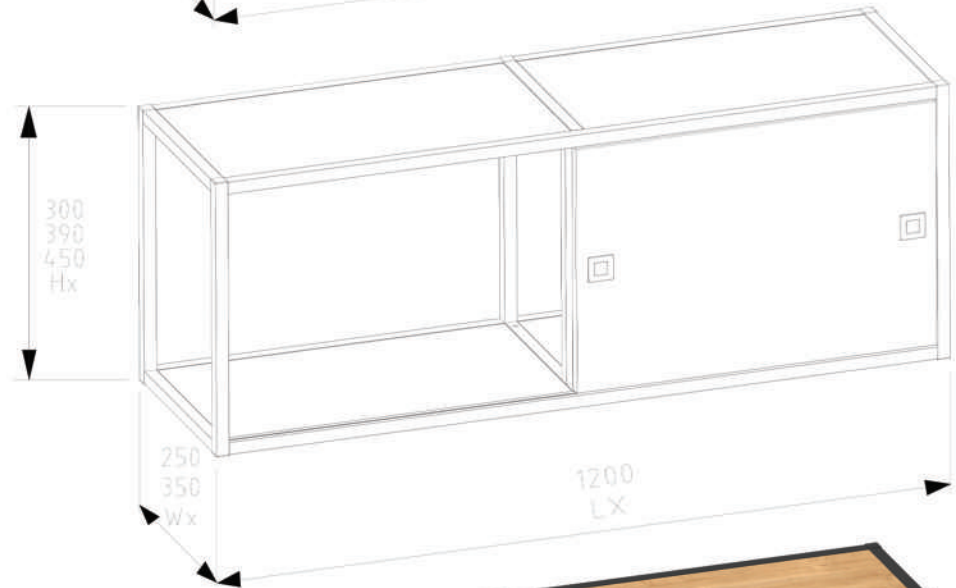
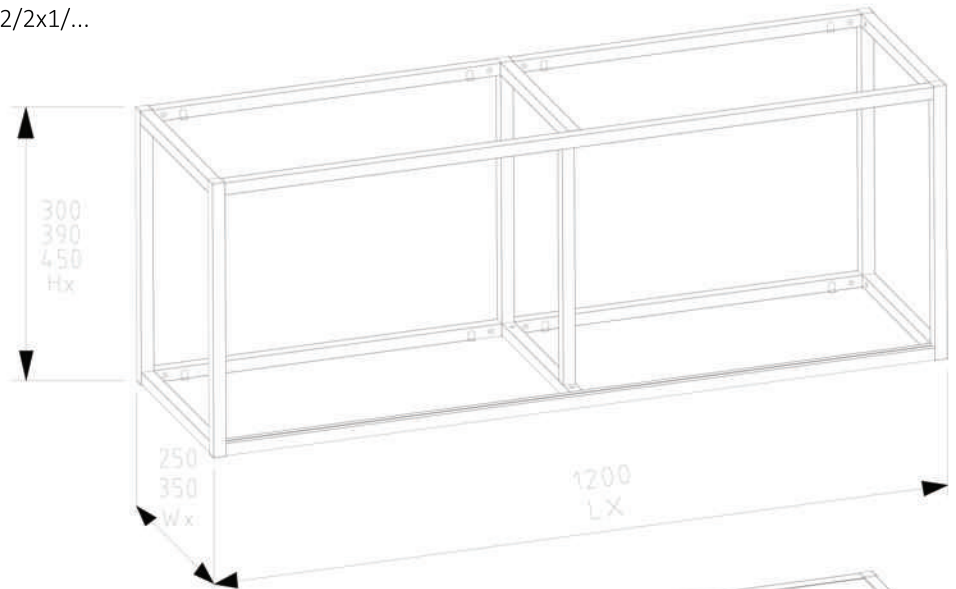

CB61.02/2X1/WW/450X350X1200/H

SESTAVLJEN CUBUS Z DRSNIMI VRATI / COMPOUND CUBUS WITH SLIDING DOORS

DRSNA VRATA Z DRSNIKI (NI VKLJUČENO)
SLIDING DOORS WITH SLIDERS (NOT INCLUDED)

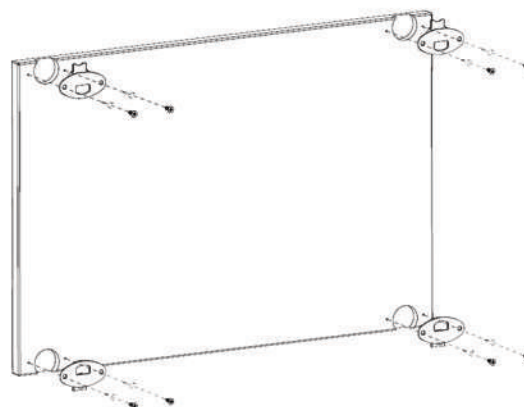

Hettich zgornji drsni element
naročniška številka: 9 115 217

Hettich upper sliding element
order number: 9 115 217

Hettich spodnji drsni element
naročniška številka: 9 115 219

Hettich bottom sliding element
order number: 9 115 219

OZNAKE SESTAVLJENIH CUBUSOV / MARKS OF COMPOUND CUBUSES

Cubus 1x1
CB61.xx/1X1



Cubus 1X2
CB61.xx/1X2



Cubus 2X2
CB61.xx/2X2

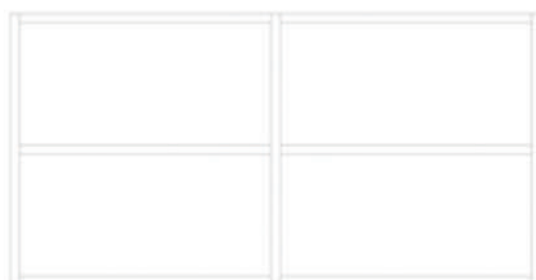

Cubus 2X1
CB61.xx/2X1



SESTAVLJEN CUBUS MULTI CUBUS 2X4 / COMPOUND MULTI CUBUS 2X4

CB61.08/2X4/...

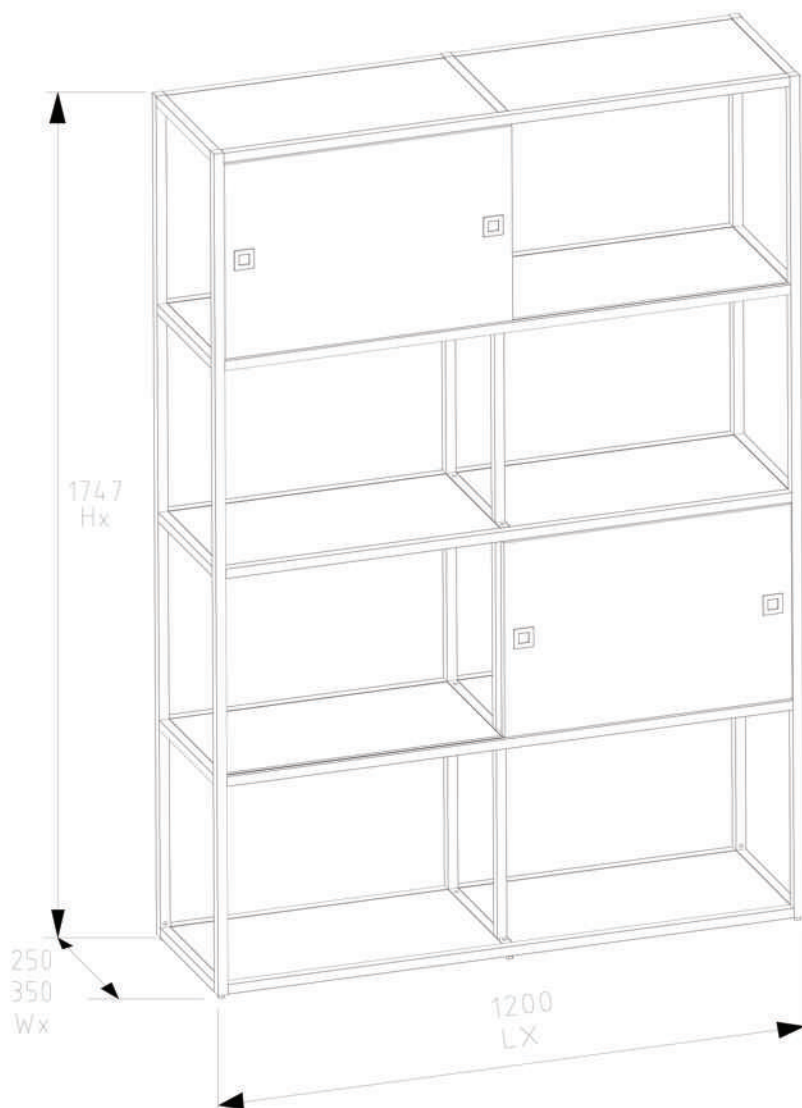

CB61.08/2X4/4w/1747X350X1200/S



Vezni element samostoječega cubusa- Nivelirna noga
Mounting component of self standing cubus- Leveling foot

POLIČNIK 1X5 / TOWER CUBUS 1X5

CB61.03/1X5/...

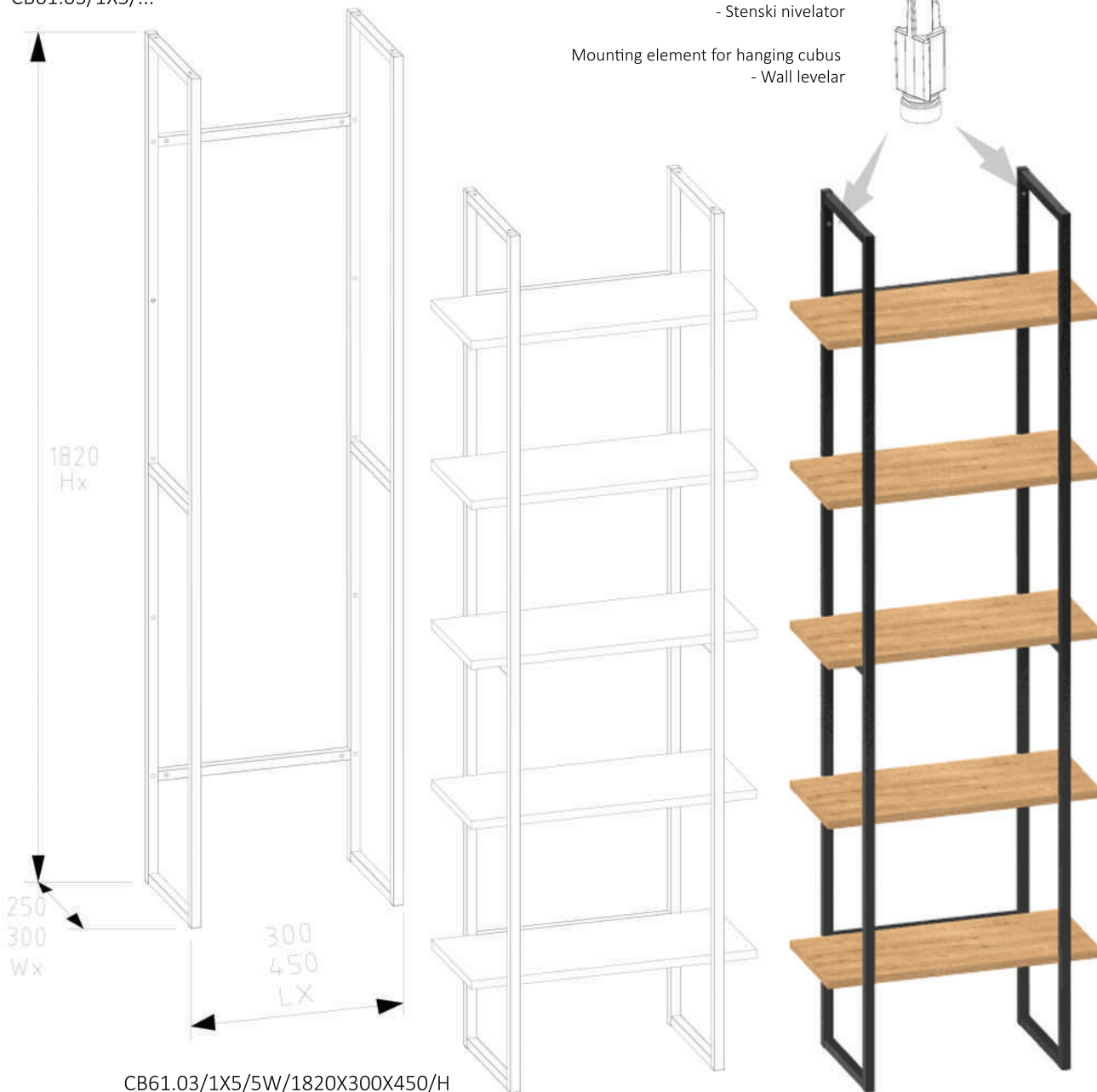

POSTOPEK NAROČILA

1. Izberite tip cubusa (*CB61.01 = osnovni cubus, CB61.02 = cubus z drsnimi vrati, CB61.03 = stolpni cubus oz. poličnik, itd.*)
2. Določite število vodoravnih in navpičnih oddelkov ti. oznake sestavljenih cubusov (*npr. 1x2, 2x4, 1x5*) **CB61.03/1X5/5W/1820X300X450/H**
3. Izberite med standardnimi dimenzijami ali podajte svoje (Hx, Wx, Lx) **CB61.03/1X5/5W/1820X300X450/H**
4. Izberite samostoječi (*oznaka S*) ali viseči (*oznaka H*) tip cubusa **CB61.03/1X5/5W/1820X300X450/H**
5. Določite tip regala med nivoji (*les, steklo, brez police*)

ORDERING STEPS

1. Select Cubus type (*i.e. CB61.01 = basic cubus, CB61.02 = cubus with sliding doors, CB61.03 = tower cubus, etc.*)
2. Define the number of horizontal and vertical compartments (*i.e. 1x2, 2x4, 1x5*) **CB61.03/1X5/5W/1820X300X450/H**
3. Choose amongst the standard dimensions or specify your own (Hx, Wx, Lx) **CB61.03/1X5/5W/1820X300X450/H**
4. Choose whether self-standing (*S*) or hanging (*H*) **CB61.03/1X5/5W/1820X300X450/H**
5. Define the shelf types between Cubus levels (*wood, glass, no shelf*)

rd rujzdesign

Furniture handles and decorative hardware | Rujz design d.o.o.
Letališka cesta 32, SI- 1000 Ljubljana

T +386 (01) 542 22 00

F +386 (01) 521 12 10

E: info@rujzdesign.com

W: www.rujzdesign.com

TRR: 02010-0010725935

VAT ID: SI69846103

