

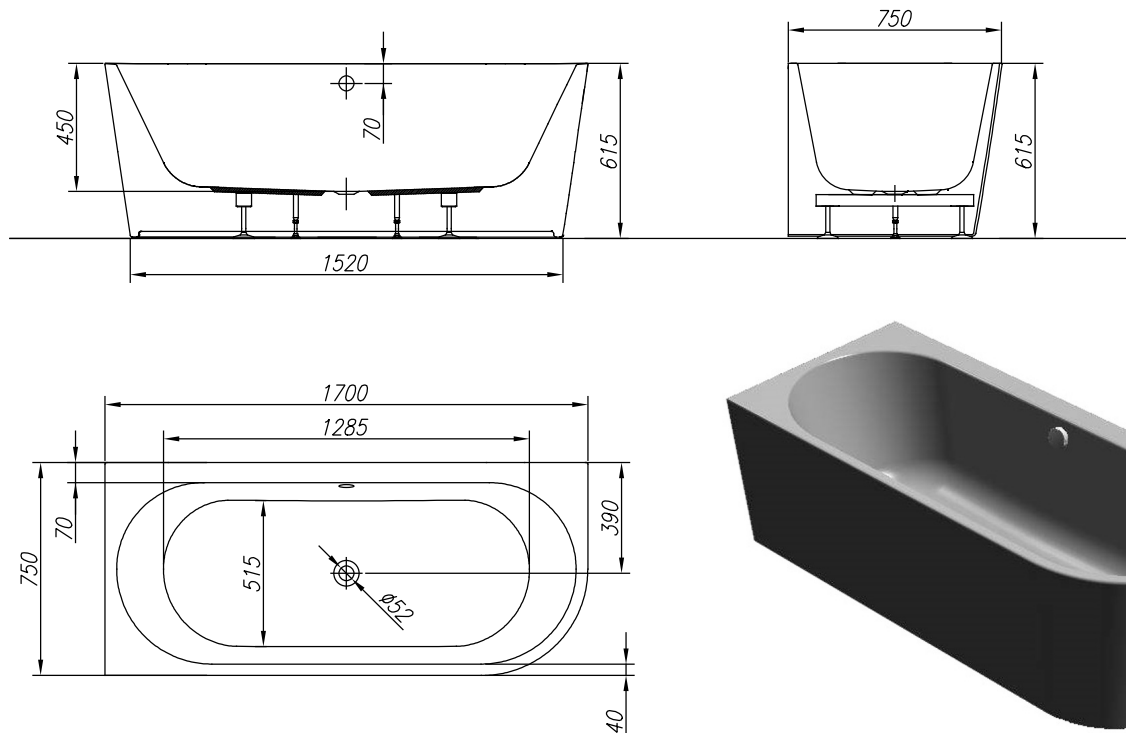

*Dream-SP-D 170x75*

PREDINSTALACIJA  
PREINSTALLATION  
VORINSTALLATION



	<p><b>215 L</b> VOLUMEN VOLUMEN VOLUME VOLUMEN</p>		<p><b>50 kg</b> TEŽA TEŽINA WEIGHT GEWICHT</p>	<p><b>365 kg</b></p>	<p>MAX. OBREMENITEV MAX. OBTEREČENJE MAX. LOAD MAX. BELASTUNG</p>		<p><b>300 kg/m<sup>2</sup></b> OBREMENITEV TAL OBTEREČENJE PODA FLOOR LOAD BODENBELASTUNG</p>
--	--	--	--	----------------------	---	--	---

-  - Prostor za električni vodnik 3x2,5 mm<sup>2</sup>, dolžine pribl. 1 m
- Mjesto za električni vodnik 3x2,5 mm<sup>2</sup>, dužine cca. 1 m
- Spot for electrical cable 3x2,5 mm<sup>2</sup>, length approx. 1 m
- Platz Stromkabel 3x2,5 mm<sup>2</sup>, Länge ungefähr 1 m

---

-  - Prostor za električni vodnik 1x6 mm<sup>2</sup> za ozemljitev, dolžine pribl. 1,5 m
- Mjesto za električni vodnik 1x6 mm<sup>2</sup> za ozemljenje, dužine cca. 1,5 m
- Spot for electrical cable 1x6 mm<sup>2</sup> for earthing, length approx. 1,5 m
- Platz Stromkabel 1x6 mm<sup>2</sup> für Erdung, Länge ungefähr 1,5 m

---

-  - Priklop tople in hladne vode 1/2", min 0,2 Mpa, max 0,4 Mpa
- Priključak tople i hladne vode 1/2", min 0,2 Mpa, max 0,4 Mpa
- Connection of hot and cold water 1/2", min 0,2Mpa, max 0,4Mpa
- Anschluss Warm- und Kaltwasser 1/2", min 0,2 Mpa, max 0,4 Mpa

---

-  - Prostor za odtok Ø 50 mm
- Mjesto za odtok Ø 50 mm
- Drain spot Ø 50mm
- Abflussplatz Ø 50 mm

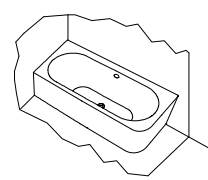

priporočilo za vgradnjo  
preporuka za ugradnju  
installation recommendation  
Einbauempfehlung

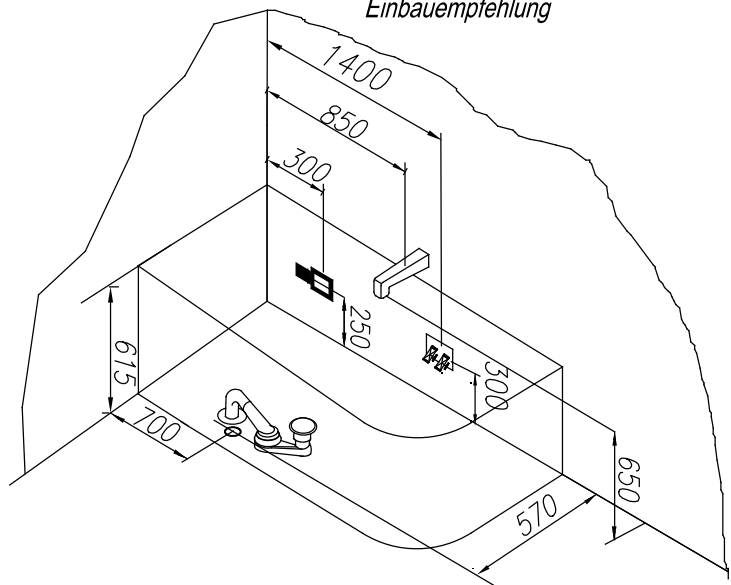

Kotna SP kopalna kad - navodilo za vgradnjo  
SP kutna kada - upute za ugradnju  
SP corner bathtub - installation instructions  
SP-Eckbadewanne - Einbauanleitung

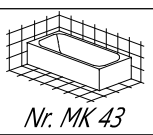



- OPCIJA ENOROČNA ARMATURA WATERFALL
- OPCIJA JEDNORUČNA ARMATURA WATERFALL
- OPTION ONE HAND FITTING WATERFALL
- MÖGLICHKEIT EINWEG-ARMATUR WATERFALL

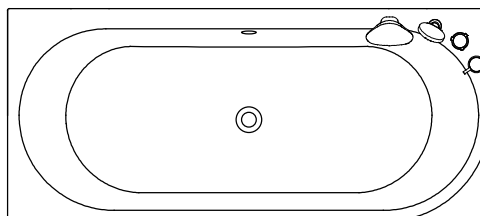
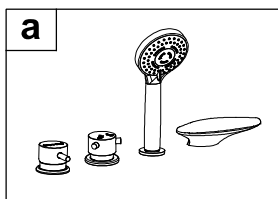

- OPCIJA ENOROČNA ARMATURA GEYSER
- OPCIJA JEDNORUČNA ARMATURA GEYSER
- OPTION ONE HAND FITTING GEYSER
- MÖGLICHKEIT EINWEG-ARMATUR GEYSER

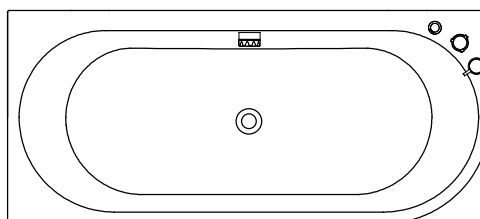
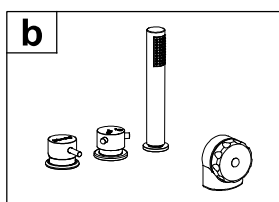



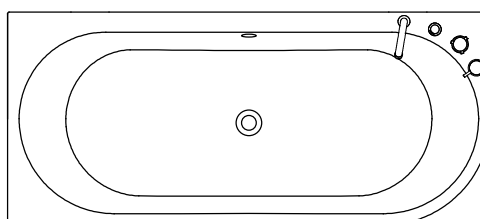
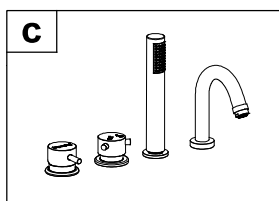



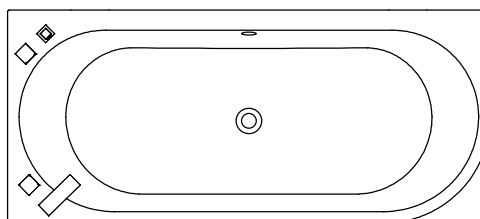
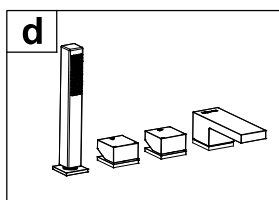

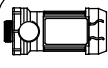
- OPCIJA ENOROČNA ARMATURA RAINDROP
- OPCIJA JEDNORUČNA ARMATURA RAINDROP
- OPTION ONE HAND FITTING RAINDROP
- MÖGLICHKEIT EINWEG-ARMATUR RAINDROP

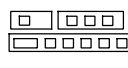

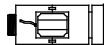
- OPCIJA ENOROČNA ARMATURA STREAM ( CHR / BLACK )
- OPCIJA JEDNORUČNA ARMATURA STREAM ( CHR / BLACK )
- OPTION ONE HAND FITTING STREAM ( CHR / BLACK )
- MÖGLICHKEIT EINWEG-ARMATUR STREAM ( CHR / BLACK )



 <ul style="list-style-type: none"> <li>- VODNA ČRPALKA</li> <li>- CRPKA ZA VODU</li> <li>- PUMP</li> <li>- WASSERPUMPE</li> </ul>	 <ul style="list-style-type: none"> <li>- VODNE ŠOBE</li> <li>- VODENE MLAZNICE</li> <li>- WATER JETS</li> <li>- WASSERDÜSEN</li> </ul>	 <ul style="list-style-type: none"> <li>- REGULATOR ZRAKA</li> <li>- REGULATOR ZRAKA</li> <li>- AIR CONTROLLER</li> <li>- LUFTRGLER</li> </ul>	 <ul style="list-style-type: none"> <li>- ELEKTRONSKA STIKALA</li> <li>- ELEKTRONSKI PREKIDAČI</li> <li>- ELECTRONIC SWITCHES</li> <li>- ELEKTROSCHALTER</li> </ul>	 <ul style="list-style-type: none"> <li>- ARMATURA IN TUŠ ROČICA</li> <li>- PIPA I TUŠ</li> <li>- FIXTURE AND SHOWER HANDLE</li> <li>- WASSERHAHN UND DUSCHE</li> </ul>
 <ul style="list-style-type: none"> <li>- ZRAČNI KOMPRESOR</li> <li>- ZRAČNI KOMPRESOR</li> <li>- BLOWER</li> <li>- LUFTPUMPE</li> </ul>	 <ul style="list-style-type: none"> <li>- ZRAČNA ŠOBA</li> <li>- ZRAČNA MLAZNICA</li> <li>- AIR JET</li> <li>- LUFTDÜSE</li> </ul>	 <ul style="list-style-type: none"> <li>- PNEVMATSKO STIKALO</li> <li>- PNEVMATSKI PREKIDAČ</li> <li>- PNEUMATIC SWITCH</li> <li>- PNEUMATIKSCHALTER</li> </ul>	 <ul style="list-style-type: none"> <li>- LUČ ALI CHROMOTERAPIJA</li> <li>- SVJETLO ILI CHROMOTERAPIJA</li> <li>- LIGHT OR CHROMOTHERAPY</li> <li>- LICHT ODER CHROMOTHERAPIE</li> </ul>	 <ul style="list-style-type: none"> <li>- PREKLOPNIK ZA MIKROŠOBE</li> <li>- PREKIDAČ ZA MIKROMLAZNICE</li> <li>- MICROJET SWITCH</li> <li>- SCHALTER FÜR MIKRODÜSEN</li> </ul>

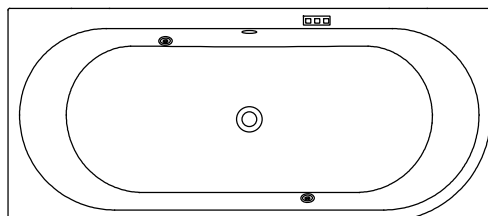

**OPCIJE**

- OPCIJA CHROMOTERAPIJA



**OPCIJE**

- OPCIJA CHROMOTERAPIJA

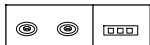

**OPTIONS**

- OPTION CHROMOTHERAPY



**MÖGLICHKEITEN**

- MÖGLICHKEIT CHROMOTHERAPIE

