

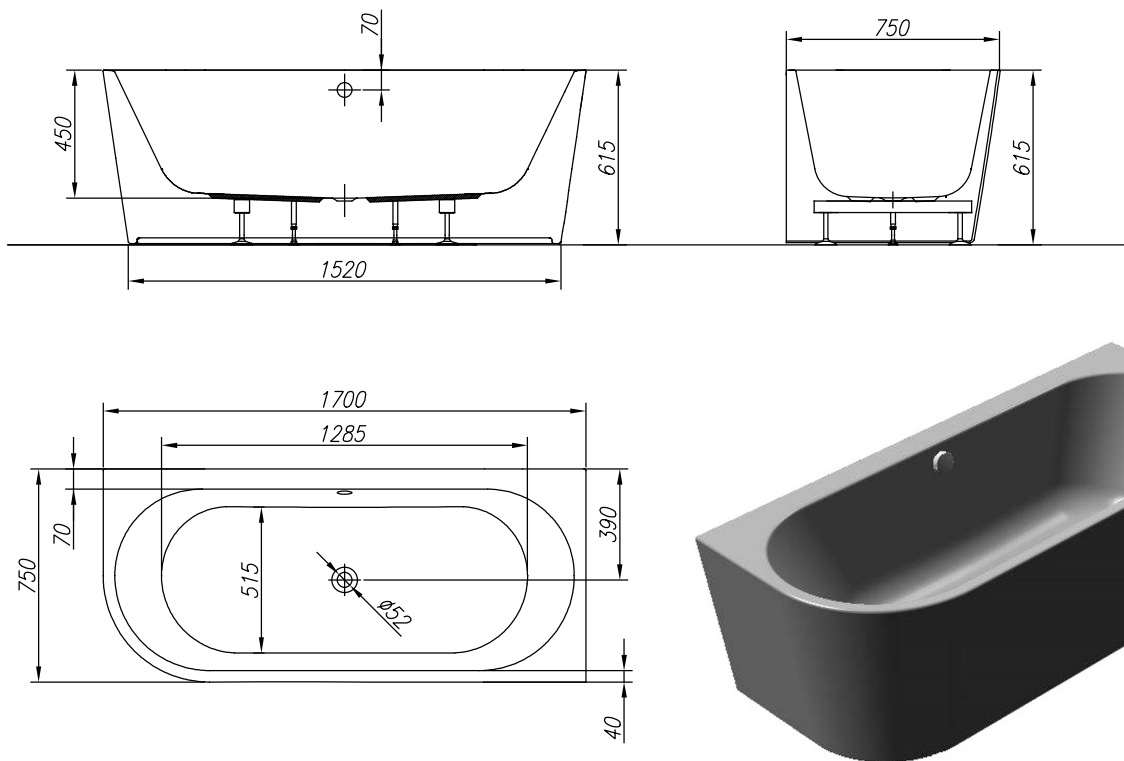

Dream-SP-L 170x75

PREDINSTALACIJA
PREINSTALLATION
VORINSTALLATION



<p>215 L</p>	<p>VOLUMEN VOLUMEN VOLUME VOLUMEN</p>	<p>50 kg</p>	<p>TEŽA TEŽINA WEIGHT GEWICHT</p>	<p>365 kg</p>	<p>MAX. OBREMENITEV MAX. OBTEREČENJE MAX. LOAD MAX. BELASTUNG</p>	<p>300 kg/m²</p> <p>OBREMENITEV TAL OBTEREČENJE PODA FLOOR LOAD BODENBELASTUNG</p>
---------------------	---	---------------------	---	----------------------	---	--

-  - Prostor za električni vodnik 3x2,5 mm², dolžine pribl. 1 m
- Mjesto za električni vodnik 3x2,5 mm², dužine cca. 1 m
- Spot for electrical cable 3x2,5 mm², length approx. 1 m
- Platz Stromkabel 3x2,5 mm², Länge ungefähr 1 m

-  - Prostor za električni vodnik 1x6 mm² za ozemljitev, dolžine pribl. 1,5 m
- Mjesto za električni vodnik 1x6 mm² za ozemljenje, dužine cca. 1,5 m
- Spot for electrical cable 1x6 mm² for earthing, length approx. 1,5 m
- Platz Stromkabel 1x6 mm² für Erdung, Länge ungefähr 1,5 m

-  - Priklop tople in hladne vode 1/2", min 0,2 Mpa, max 0,4 Mpa
- Priključak tople i hladne vode 1/2", min 0,2 Mpa, max 0,4 Mpa
- Connection of hot and cold water 1/2", min 0,2Mpa, max 0,4Mpa
- Anschluss Warm- und Kaltwasser 1/2", min 0,2 Mpa, max 0,4 Mpa

-  - Prostor za odtok Ø 50 mm
- Mjesto za odtok Ø 50 mm
- Drain spot Ø 50mm
- Abflussplatz Ø 50 mm

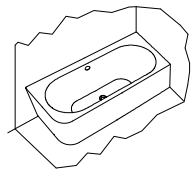

preporočilo za vgradnjo
preporuka za ugradnju
installation recommendation
Einbauempfehlung

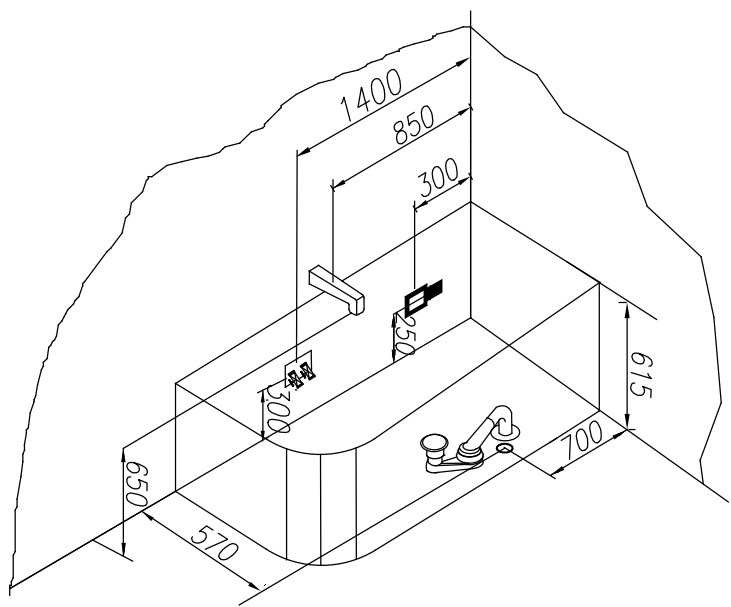

Kotna SP kopalna kad - navodilo za vgradnjo
SP kutna kada - upute za ugradnju
SP corner bathtub - installation instructions
SP-Eckbadewanne - Einbauanleitung

Nr. MK 43



- OPCIJA ENOROČNA ARMATURA WATERFALL
- OPCIJA JEDNORUČNA ARMATURA WATERFALL
- OPTION ONE HAND FITTING WATERFALL
- MÖGLICHKEIT EINWEG-ARMATUR WATERFALL

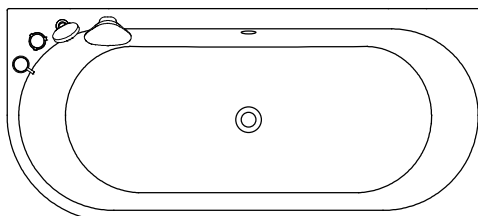
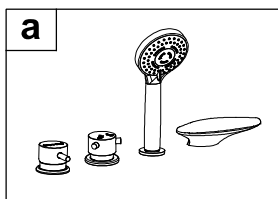

- OPCIJA ENOROČNA ARMATURA GEYSER
- OPCIJA JEDNORUČNA ARMATURA GEYSER
- OPTION ONE HAND FITTING GEYSER
- MÖGLICHKEIT EINWEG-ARMATUR GEYSER

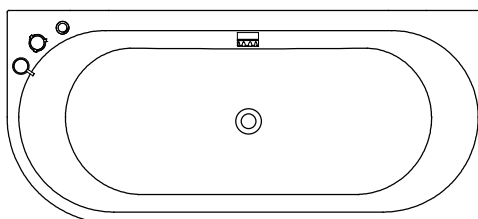
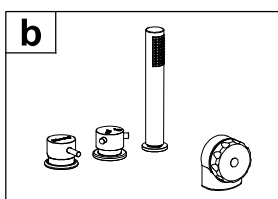

- OPCIJA ENOROČNA ARMATURA RAINDROP
- OPCIJA JEDNORUČNA ARMATURA RAINDROP
- OPTION ONE HAND FITTING RAINDROP
- MÖGLICHKEIT EINWEG-ARMATUR RAINDROP

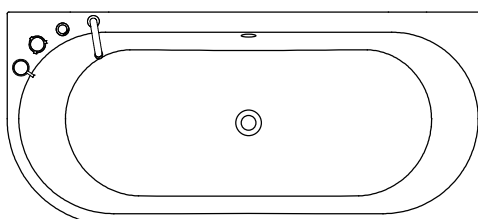
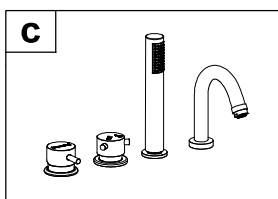

- OPCIJA ENOROČNA ARMATURA STREAM (CHR / BLACK)
- OPCIJA JEDNORUČNA ARMATURA STREAM (CHR / BLACK)
- OPTION ONE HAND FITTING STREAM (CHR / BLACK)
- MÖGLICHKEIT EINWEG-ARMATUR STREAM (CHR / BLACK)

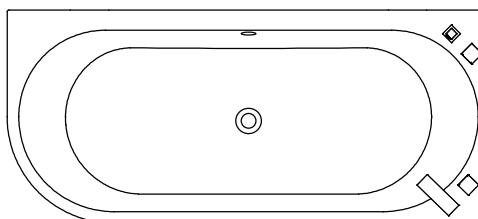
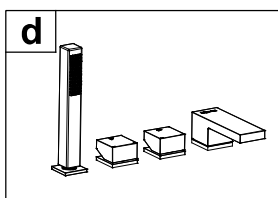

DREAM-SP-L 170x75

POLOŽAJ STIKAL IN AGREGATOV PRI RAZLIČNIH IZVEDBAH MASAŽNIH SISTEMOV
MJESTO PREKIDAČA I AGREGATA KOT RAZLIČITIH IZVEDBI MASAŽNIH SISTEMA
POSITION OF SWITCHES AND GENERATORS IN DIFFERENT VERSIONS OF MASSAGE SYSTEMS
POSITION SCHALTER UND AGGREGATE BEI VERSCHIEDENEN AUSFÜHRUNGEN VON MASSAGESYSTEMEN

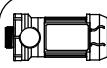

- VODNA ČRPALKA
 - CRPKA ZA VODU
 - PUMP
 - WASSERPUMPE



- VODNE ŠOBE
 - VODNE MLAZNICE
 - WATER JETS
 - WASSERDÜSEN



- REGULATOR ZRAKA
 - REGULATOR ZRAKA
 - AIR CONTROLLER
 - LUFTRGLER

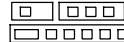

- ELEKTRONSKA STIKALA
 - ELEKTRONSKI PREKIDAČI
 - ELECTRONIC SWITCHES
 - ELEKTROSCHALTER



- ARMATURA IN TUŠ ROČICA
 - PIPA I TUŠ
 - FIXTURE AND SHOWER HANDLE
 - WASSERHAHN UND DUSCHE

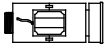

- ZRAČNI KOMPRESOR
 - ZRAČNI KOMPRESOR
 - BLOWER
 - LUFTPUMPE



- ZRAČNA ŠOBA
 - ZRAČNA MLAZNICA
 - AIR JET
 - LUFTDÜSE



- PNEVMATSKO STIKALO
 - PNEVMATSKI PREKIDAČ
 - PNEUMATIC SWITCH
 - PNEUMATIKSCHALTER



- LUČ ALI CHROMOTERAPIJA
 - SVJETLO ILI CHROMOTERAPIJA
 - LIGHT OR CHROMOTHERAPY
 - LICHT ODER CHROMOTHERAPIE



- PREKLOPNIK ZA MIKROŠOBE
 - PREKIDAČ ZA MIKROMLAZNICE
 - MICROJET SWITCH
 - SCHALTER FÜR MIKRODÜSEN

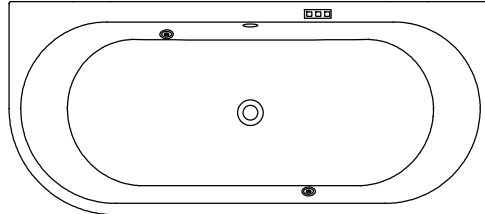

OPCIJE

- OPCIJA CHROMOTERAPIJA



OPCIJE

- OPCIJA CHROMOTERAPIJA



OPTIONS

- OPTION CHROMOTHERAPY



MÖGLICHKEITEN

- MÖGLICHKEIT CHROMOTHERAPIE

