

Comodo-FS 185x90

PREDINSTALACIJA
PREINSTALLATION
VORINSTALLATION

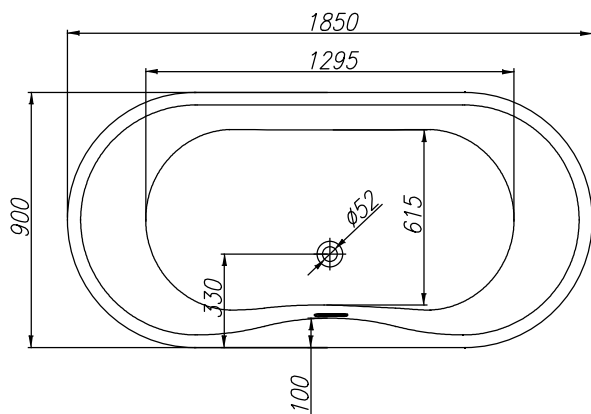
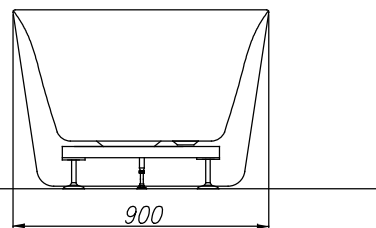
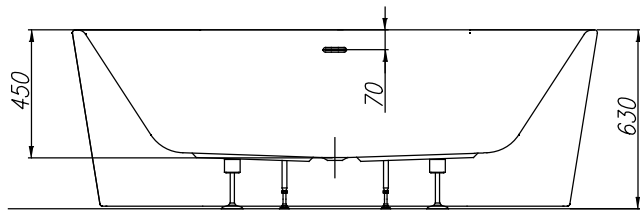

285 L

VOLUMEN
VOLUMEN
VOLUME
VOLUMEN



54 kg

TEŽA
TEŽINA
WEIGHT
GEWICHT

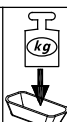

445 kg

MAX. OBREMENITEV
MAX. OBTEREČENJE
MAX. LOAD
MAX. BELASTUNG

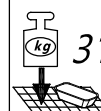

310 kg/m²

OBREMENITEV TAL
OBTEREČENJE PODA
FLOOR LOAD
BODENBELASTUNG

- Prostor za električni vodnik 3x2,5 mm², dolžine pribl. 1 m
- Mjesto za električni vodnik 3x2,5 mm², dužine cca. 1 m
- Spot for electrical cable 3x2,5 mm², length approx. 1 m
- Platz Stromkabel 3x2,5 mm², Länge ungefähr 1 m
- Prostor za električni vodnik 1x6 mm² za ozemljitev, dolžine pribl. 1,5 m
- Mjesto za električni vodnik 1x6 mm² za ozemljenje, dužine cca. 1,5 m
- Spot for electrical cable 1x6 mm² for earthing, length approx. 1.5 m
- Platz Stromkabel 1x6 mm² für Erdung, Länge ungefähr 1,5 m
- Priklop tople in hladne vode 1/2", min 0,2 Mpa, max 0,4 Mpa
- Priključak tople i hladne vode 1/2", min 0,2 Mpa, max 0,4 Mpa
- Connection of hot and cold water 1/2", min 0.2Mpa, max 0.4Mpa
- Anschluss Warm- und Kaltwasser 1/2", min 0,2 Mpa, max 0,4 Mpa

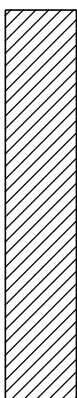

- Prostor za odtok Ø 50 mm
- Mjesto za odtok Ø 50 mm
- Drain spot Ø 50mm
- Abflussplatz Ø 50 mm

priporočilo za vgradnjo
preporuka za ugradnju
installation recommendation
Einbauempfehlung

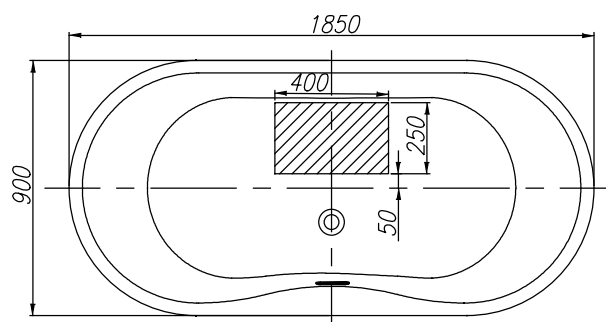

Samostoječa FS kopalna kad - navodilo za vgradnjo
FS samostojeća kada - upute za ugradnju
FS freestanding bathtub - installation instructions
FS Freistehende Badewanne - Einbauanleitung

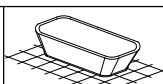

Nr. MK 44

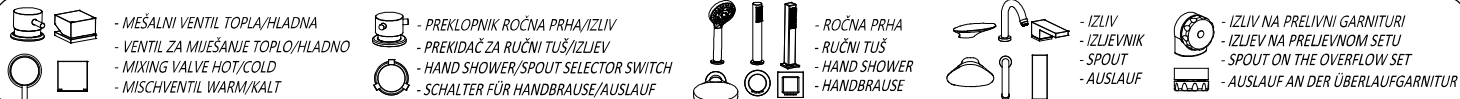

- OPCIJA ENOROČNA ARMATURA WATERFALL
- OPCIJA JEDNORUČNA ARMATURA WATERFALL
- OPTION ONE HAND FITTING WATERFALL
- MÖGLICHKEIT EINWEG-ARMATUR WATERFALL

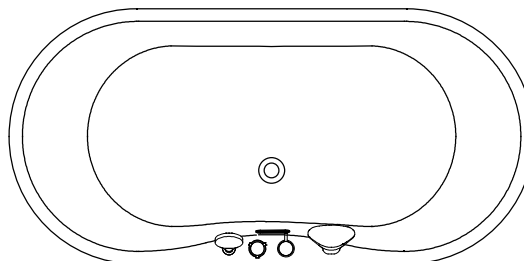
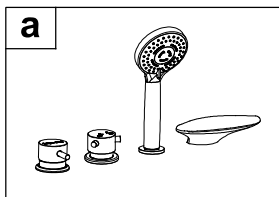

- OPCIJA ENOROČNA ARMATURA GEYSER
- OPCIJA JEDNORUČNA ARMATURA GEYSER
- OPTION ONE HAND FITTING GEYSER
- MÖGLICHKEIT EINWEG-ARMATUR GEYSER

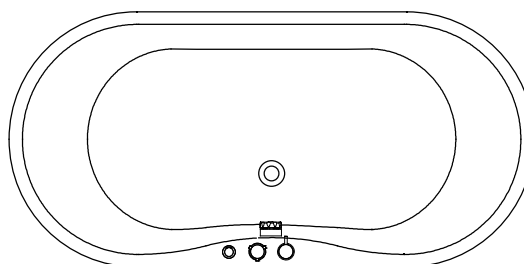
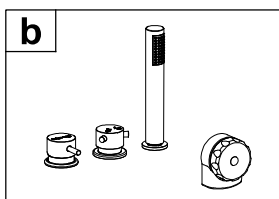



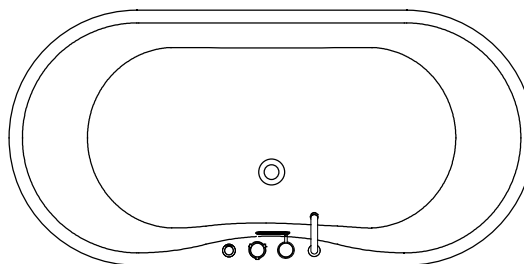
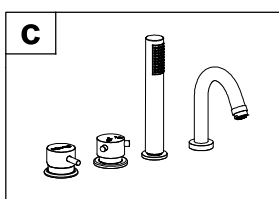



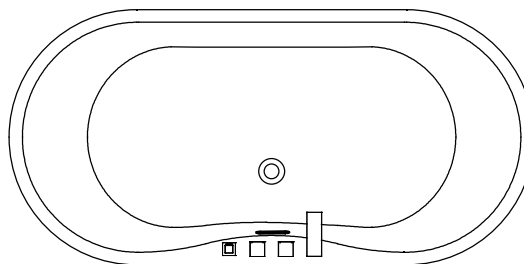
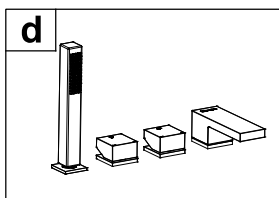

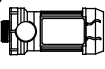
- OPCIJA ENOROČNA ARMATURA RAINDROP
- OPCIJA JEDNORUČNA ARMATURA RAINDROP
- OPTION ONE HAND FITTING RAINDROP
- MÖGLICHKEIT EINWEG-ARMATUR RAINDROP

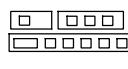

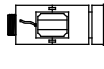
- OPCIJA ENOROČNA ARMATURA STREAM (CHR / BLACK)
- OPCIJA JEDNORUČNA ARMATURA STREAM (CHR / BLACK)
- OPTION ONE HAND FITTING STREAM (CHR / BLACK)
- MÖGLICHKEIT EINWEG-ARMATUR STREAM (CHR / BLACK)



	- VODNA ČRPALKA - CRPKA ZA VODU - PUMP - WASSERPUMPE		- VODNE ŠOBE - VODENE MLAZNICE - WATER JETS - WASSERDÜSEN		- REGULATOR ZRAKA - REGULATOR ZRAKA - AIR CONTROLLER - LUFTRGLER		- ELEKTRONSKA STIKALA - ELEKTRONSKI PREKIDAČI - ELECTRONIC SWITCHES - ELEKTROSCHALTER		- ARMATURA IN TUŠ ROČICA - PIPA I TUŠ - FIXTURE AND SHOWER HANDLE - WASSERHAHN UND DUSCHE
	- ZRAČNI KOMPRESOR - ZRAČNI KOMPRESOR - BLOWER - LUFTPUMPE		- ZRAČNA ŠOBA - ZRAČNA MLAZNICA - AIR JET - LUFTDÜSE		- PNEVMATSKO STIKALO - PNEVMATSKI PREKIDAČ - PNEUMATIC SWITCH - PNEUMATIKSCHALTER		- LUČ ALI CHROMOTERAPIJA - SVJETLO ILI CHROMOTERAPIJA - LIGHT OR CHROMOTHERAPY - LICHT ODER CHROMOTHERAPIE		- PREKLOPNIK ZA MIKROŠOBE - PREKIDAČ ZA MIKROMLAZNICE - MICROJET SWITCH - SCHALTER FÜR MIKRODÜSEN

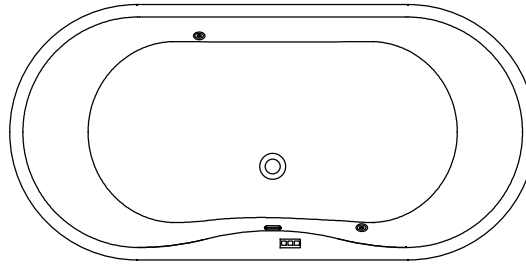

OPCIJE

- OPCIJA CHROMOTERAPIJA



OPCIJE

- OPCIJA CHROMOTERAPIJA

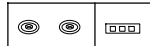

OPTIONS

- OPTION CHROMOTHERAPY

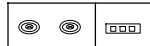

MÖGLICHKEITEN

- MÖGLICHKEIT CHROMOTHERAPIE

