

Copelia LIGHT-FS 180x80

PREDINSTALACIJA
PREINSTALLATION
VORINSTALLATION

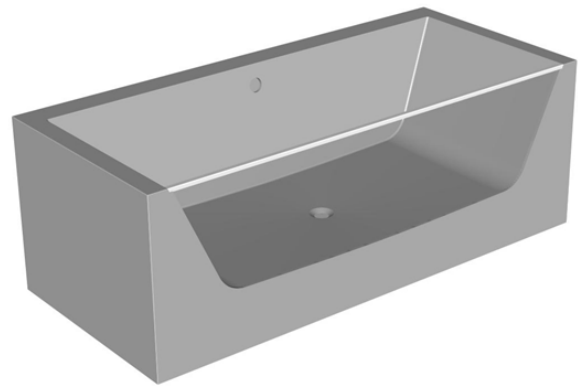
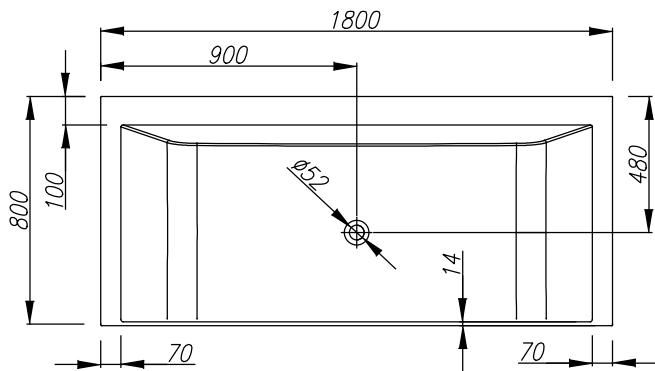
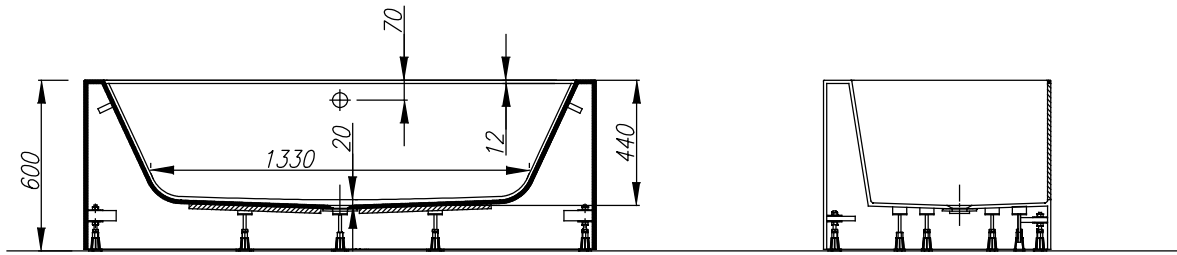
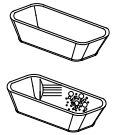

310 L

VOLUMEN
VOLUMEN
VOLUME
VOLUMEN

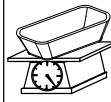

120 kg

TEŽA
TEŽINA
WEIGHT
GEWICHT

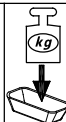

530 kg

MAX. OBREMENITEV
MAX. OBTEREČENJE
MAX. LOAD
MAX. BELASTUNG

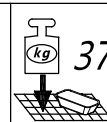

370 kg/m²

OBREMENITEV TAL
OBTEREČENJE PODA
FLOOR LOAD
BODENBELASTUNG

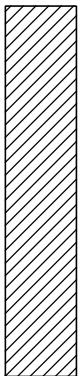

- Prostor za električni vodnik 3x2,5 mm², dolžine pribl. 1 m
- Mjesto za električni vodnik 3x2,5 mm², dužine cca. 1 m
- Spot for electrical cable 3x2,5 mm², length approx. 1 m
- Platz Stromkabel 3x2,5 mm², Länge ungefähr 1 m
- Prostor za električni vodnik 1x6 mm² za ozemljitev, dolžine pribl. 1,5 m
- Mjesto za električni vodnik 1x6 mm² za ozemljenje, dužine cca. 1,5 m
- Spot for electrical cable 1x6 mm² for earthing, length approx. 1,5 m
- Platz Stromkabel 1x6 mm² für Erdung, Länge ungefähr 1,5 m
- Priklop tople in hladne vode 1/2", min 0,2 Mpa, max 0,4 Mpa
- Priključak tople i hladne vode 1/2", min 0,2 Mpa, max 0,4 Mpa
- Connection of hot and cold water 1/2", min 0,2Mpa, max 0,4Mpa
- Anschluss Warm- und Kaltwasser 1/2", min 0,2 Mpa, max 0,4 Mpa
- Prostor za odtok Ø 50 mm
- Mjesto za odtok Ø 50 mm
- Drain spot Ø 50mm
- Abflussplatz Ø 50 mm

prporočilo za vgradnjo
preporuka za ugradnju
installation recommendation
Einbauempfehlung

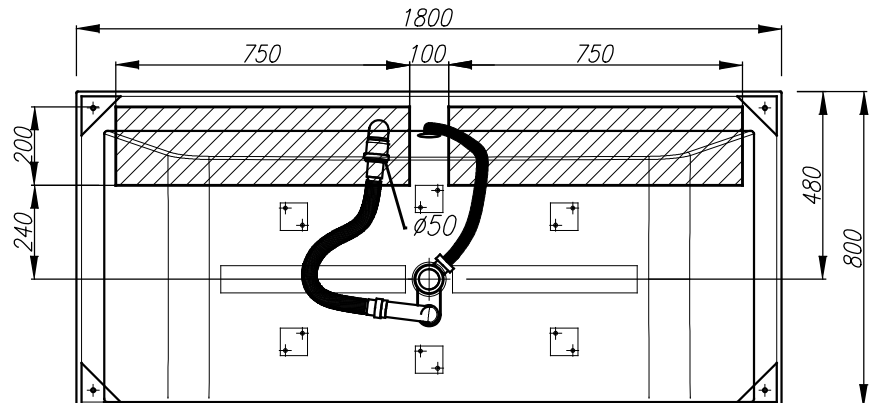

Samostoječa FS kopalna kad - navodilo za vgradnjo
FS samostojeća kada - upute za ugradnju
FS freestanding bathtub - installation instructions
FS Freistehende Badewanne - Einbauanleitung



Nr. MKKE 34

Kopalna kad iz KERROCK-a
Kada za kupanje iz KERROCK-a
Bathtub from KERROCK
Badewanne aus KERROCK

POLOŽAJ ARMATURE S TUŠ ROČICO IN IZLIVOM ZA POLNENJE KADI
POLOŽAJ ARMATURE SA TUŠ RUČICOM I IZLJEVOM ZA PUNJENJE KADE
POSITION OF THE FITTING WITH SHOWER HANDLE AND SPOUT FOR FILLING THE BATHTUB
POSITION DER ARMATUR MIT BRAUSEGRIFF UND AUSLAUF ZUM BEFÜLLEN DER BADEWANNE



- OPCIJA ENOROČNA ARMATURA WATERFALL
- OPCIJA JEDNORUČNA ARMATURA WATERFALL
- OPTION ONE HAND FITTING WATERFALL
- MÖGLICHKEIT EINWEG-ARMATUR WATERFALL

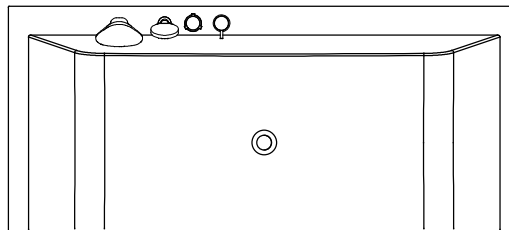
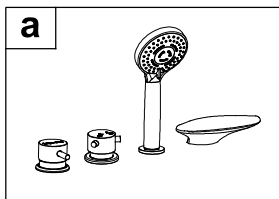

- OPCIJA ENOROČNA ARMATURA GEYSER
- OPCIJA JEDNORUČNA ARMATURA GEYSER
- OPTION ONE HAND FITTING GEYSER
- MÖGLICHKEIT EINWEG-ARMATUR GEYSER

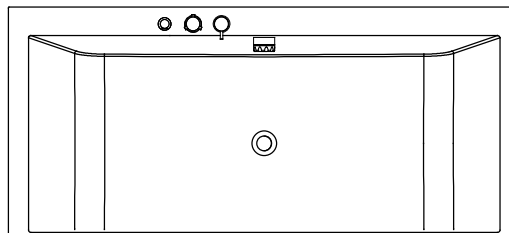
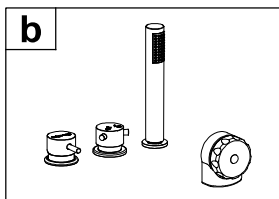

- OPCIJA ENOROČNA ARMATURA RAINDROP
- OPCIJA JEDNORUČNA ARMATURA RAINDROP
- OPTION ONE HAND FITTING RAINDROP
- MÖGLICHKEIT EINWEG-ARMATUR RAINDROP

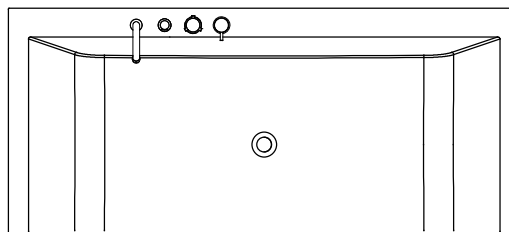
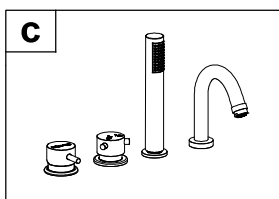

- OPCIJA ENOROČNA ARMATURA STREAM (CHR / BLACK)
- OPCIJA JEDNORUČNA ARMATURA STREAM (CHR / BLACK)
- OPTION ONE HAND FITTING STREAM (CHR / BLACK)
- MÖGLICHKEIT EINWEG-ARMATUR STREAM (CHR / BLACK)

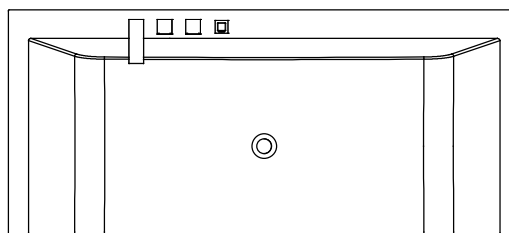
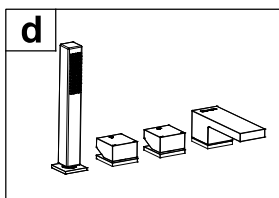

COPELIA LIGHT-FS

180x80

POLOŽAJ STIKAL IN AGREGATOV PRI RAZLIČNIH IZVEDBAH MASAŽNIH SISTEMOV

MJESTO PREKIDAČA I AGREGATA KOT RAZLIČITIH IZVEDBI MASAŽNIH SISTEMA

POSITION OF SWITCHES AND GENERATORS IN DIFFERENT VERSIONS OF MASSAGE SYSTEMS

POSITION SCHALTER UND AGGREGATE BEI VERSCHIEDENEN AUSFÜHRUNGEN VON MASSAGESYSTEMEN

3/3

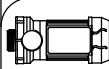

- VODNA ČRPALKA
- CRPKA ZA VODU
- PUMP
- WASSERPUMPE



- VODNE ŠOBE
- VODENE MLAZNICE
- WATER JETS
- WASSERDÜSEN



- REGULATOR ZRAKA
- REGULATOR ZRAKA
- AIR CONTROLLER
- LUFTRGLER



- ELEKTRONSKA STIKALA
- ELEKTRONSKI PREKIDAČI
- ELECTRONIC SWITCHES
- ELEKTROSCHALTER



- ARMATURA IN TUŠ ROČICA
- PIPA I TUŠ
- FIXTURE AND SHOWER HANDLE
- WASSERHAHN UND DUSCHE

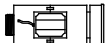

- ZRAČNI KOMPRESOR
- ZRAČNI KOMPRESOR
- BLOWER
- LUFTPUMPE



- ZRAČNA ŠOBA
- ZRAČNA MLAZNICA
- AIR JET
- LUFTDÜSE



- PNEVMATSKO STIKALO
- PNEVMATSKI PREKIDAČ
- PNEUMATIC SWITCH
- PNEUMATIKSCHALTER



- LUČ ALI CHROMOTERAPIJA
- SVJETLO ILI CHROMOTERAPIJA
- LIGHT OR CHROMOTHERAPY
- LICHT ODER CHROMOTHERAPIE



- PREKLOPNIK ZA MIKROŠOBE
- PREKIDAČ ZA MIKROMLAZNICE
- MICROJET SWITCH
- SCHALTER FÜR MIKRODÜSEN

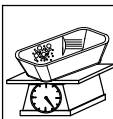
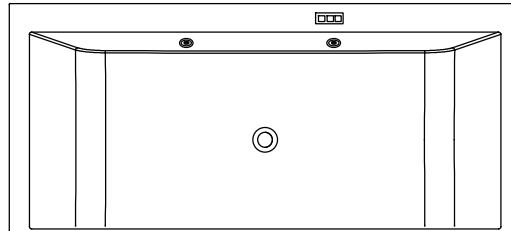

TEŽA
TEŽINA
WEIGHT
GEWICHT

123 kg

CHROMOTERAPIJA
- ELEKTRONSKO STIKALO
- CHROMOTERAPIJA 2xLED

CHROMOTERAPIJA
- ELEKTRONSKI PREKIDAČ
- CHROMOTERAPIJA 2xLED

CHROMOTHERAPY
- ELECTRONIC SWITCH
- CHROMOTHERAPY 2xLED

CHROMOTHERAPIE
- ELEKTROSCHALTER
- CHROMOTHERAPIE 2xLED