

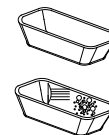

Dream-SP 170x75

PREDINSTALACIJA
PREINSTALLATION
VORINSTALLATION

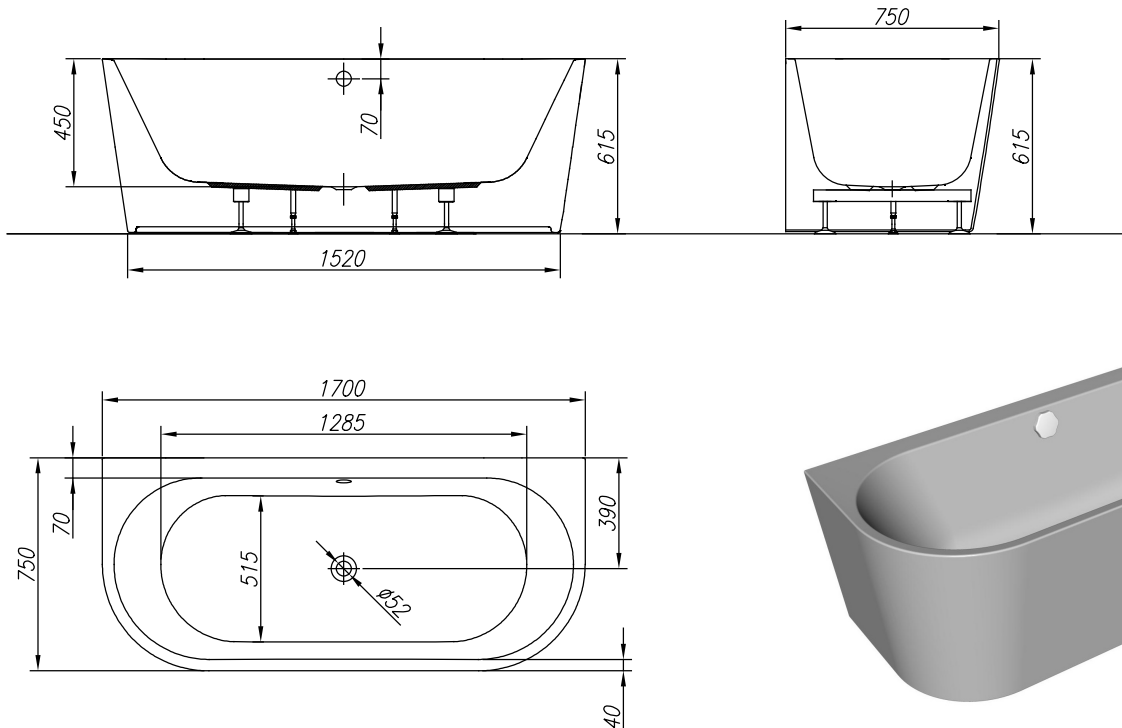

	<p>215 L VOLUMEN VOLUMEN VOLUME VOLUMEN</p>		<p>54 kg TEŽA TEŽINA WEIGHT GEWICHT</p>		<p>365 kg MAX. OBREMENITEV MAX. OBTEREČENJE MAX. LOAD MAX. BELASTUNG</p>		<p>300 kg/m² OBREMENITEV TAL OBTEREČENJE PODA FLOOR LOAD BODENBELASTUNG</p>
--	--	--	--	--	---	--	---

-  - Prostor za električni vodnik 3x2,5 mm², dolžine pribl. 1 m
- Mjesto za električni vodnik 3x2,5 mm², dužine cca. 1 m
- Spot for electrical cable 3x2,5 mm², length approx. 1 m
- Platz Stromkabel 3x2,5 mm², Länge ungefähr 1 m

-  - Prostor za električni vodnik 1x6 mm² za ozemljitev, dolžine pribl. 1,5 m
- Mjesto za električni vodnik 1x6 mm² za ozemljenje, dužine cca. 1,5 m
- Spot for electrical cable 1x6 mm² for earthing, length approx. 1.5 m
- Platz Stromkabel 1x6 mm² für Erdung, Länge ungefähr 1,5 m

-  - Priklop tople in hladne vode 1/2", min 0,2 Mpa, max 0,4 Mpa
- Priključak tople i hladne vode 1/2", min 0,2 Mpa, max 0,4 Mpa
- Connection of hot and cold water 1/2", min 0.2Mpa, max 0.4Mpa
- Anschluss Warm- und Kaltwasser 1/2", min 0,2 Mpa, max 0,4 Mpa

-  - Prostor za odtok Ø 50 mm
- Mjesto za odtok Ø 50 mm
- Drain spot Ø 50mm
- Abflussplatz Ø 50 mm

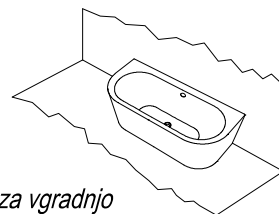

priporočilo za vgradnjo
preporuka za ugradnju
installation recommendation
Einbauempfehlung

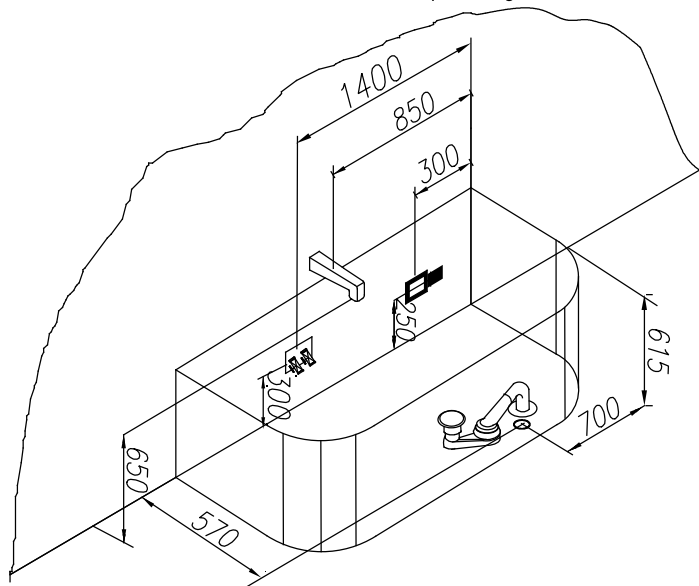

SP kopalna kad - navodilo za vgradnjo
SP kada - upute za ugradnju
SP bathtub - installation instructions
SP-Badewanne - Einbauanleitung

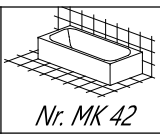

Nr. MK 42



- OPCIJA ENOROČNA ARMATURA WATERFALL
- OPCIJA JEDNORUČNA ARMATURA WATERFALL
- OPTION ONE HAND FITTING WATERFALL
- MÖGLICHKEIT EINWEG-ARMATUR WATERFALL

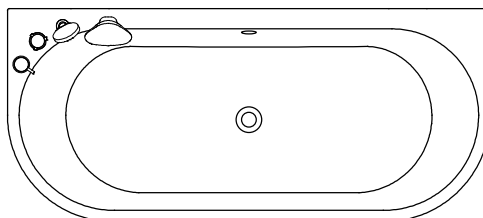
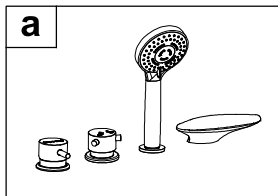

- OPCIJA ENOROČNA ARMATURA GEYSER
- OPCIJA JEDNORUČNA ARMATURA GEYSER
- OPTION ONE HAND FITTING GEYSER
- MÖGLICHKEIT EINWEG-ARMATUR GEYSER

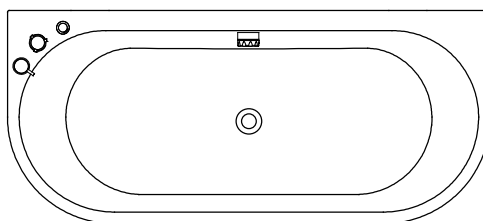
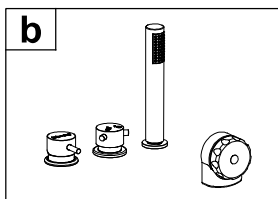



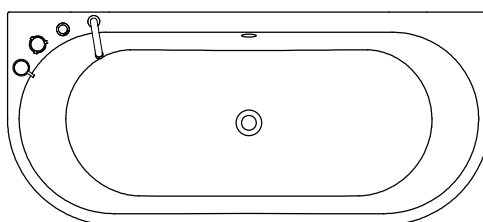
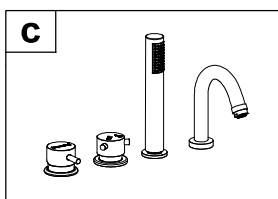



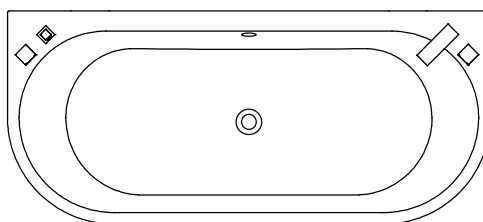
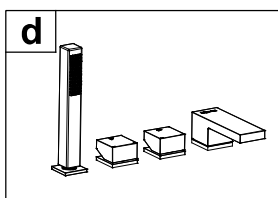

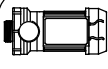
- OPCIJA ENOROČNA ARMATURA RAINDROP
- OPCIJA JEDNORUČNA ARMATURA RAINDROP
- OPTION ONE HAND FITTING RAINDROP
- MÖGLICHKEIT EINWEG-ARMATUR RAINDROP

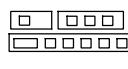

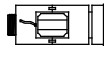
- OPCIJA ENOROČNA ARMATURA STREAM (CHR / BLACK)
- OPCIJA JEDNORUČNA ARMATURA STREAM (CHR / BLACK)
- OPTION ONE HAND FITTING STREAM (CHR / BLACK)
- MÖGLICHKEIT EINWEG-ARMATUR STREAM (CHR / BLACK)



	- VODNA ČRPALKA - CRPKA ZA VODU - PUMP - WASSERPUMPE		- VODNE ŠOBE - VODENE MLAZNICE - WATER JETS - WASSERDÜSEN		- REGULATOR ZRAKA - REGULATOR ZRAKA - AIR CONTROLLER - LUFTRGLER		- ELEKTRONSKA STIKALA - ELEKTRONSKI PREKIDAČI - ELECTRONIC SWITCHES - ELEKTROSCHALTER		- ARMATURA IN TUŠ ROČICA - PIPA I TUŠ - FIXTURE AND SHOWER HANDLE - WASSERHAHN UND DUSCHE
	- ZRAČNI KOMPRESOR - ZRAČNI KOMPRESOR - BLOWER - LUFTPUMPE		- ZRAČNA ŠOBA - ZRAČNA MLAZNICA - AIR JET - LUFTDÜSE		- PNEVMATSKO STIKALO - PNEVMATSKI PREKIDAČ - PNEUMATIC SWITCH - PNEUMATIKSCHALTER		- LUČ ALI CHROMOTERAPIJA - SVJETLO ILI CHROMOTERAPIJA - LIGHT OR CHROMOTHERAPIE - LICHT ODER CHROMOTHERAPIE		- PREKLOPNIK ZA MIKROŠOBE - PREKIDAČ ZA MIKROMLAZNICE - MICROJET SWITCH - SCHALTER FÜR MIKRODÜSEN

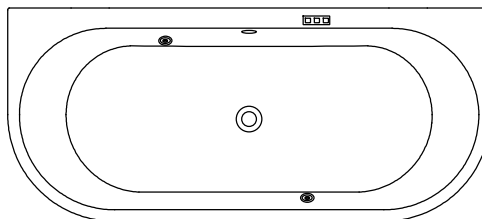

OPCIJE

- OPCIJA CHROMOTERAPIJA

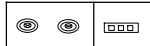

OPCIJE

- OPCIJA CHROMOTERAPIJA

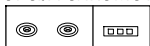

OPTIONS

- OPTION CHROMOTHERAPY

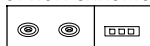

MÖGLICHKEITEN

- MÖGLICHKEIT CHROMOTHERAPIE

