

**Kolpa-san**  
by KOLPA

- SI** Montažno navodilo
- HR** Upute za montažu
- BIH** Upute za montažu
- SRB** Uputstva za montažu
- BIH** Uputstva za montažu
- CG** Uputstva za montažu
- MK** Нструкции за монтажа
- HU** Szerelési utasítás
- GB** Assembly Instructions
- DE** Einbauanleitungen
- RU** Инструкция по монтажу
- FR** Instruction d'assemblage

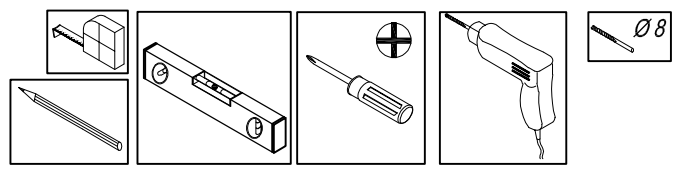
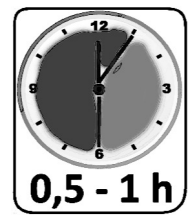
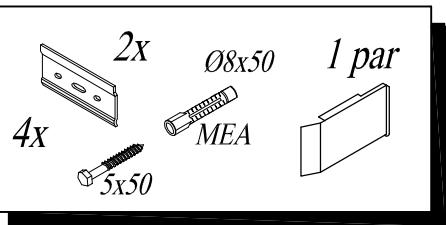
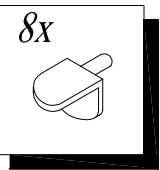
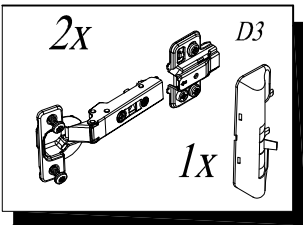
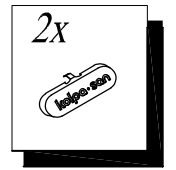
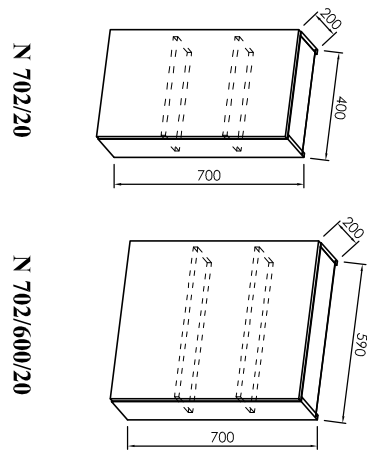

Tip: NAOMI - N 702/20 ; N 702/600/20

2

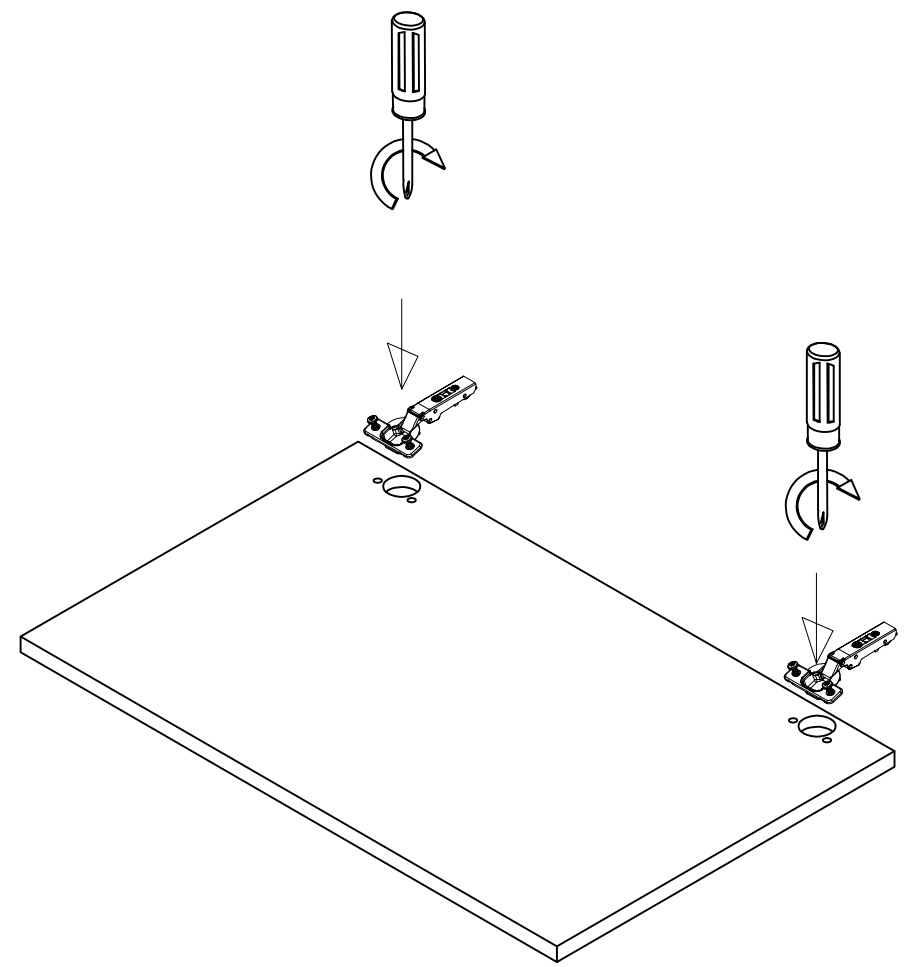
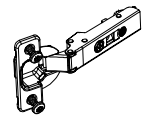

3

