

PREDINSTALACIJA
PREDINSTALACIJA

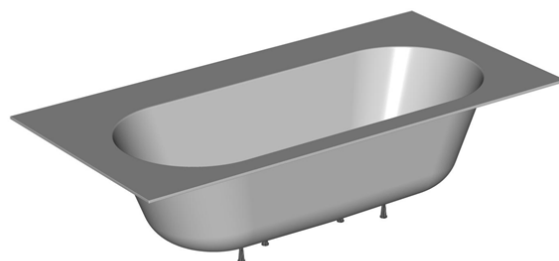
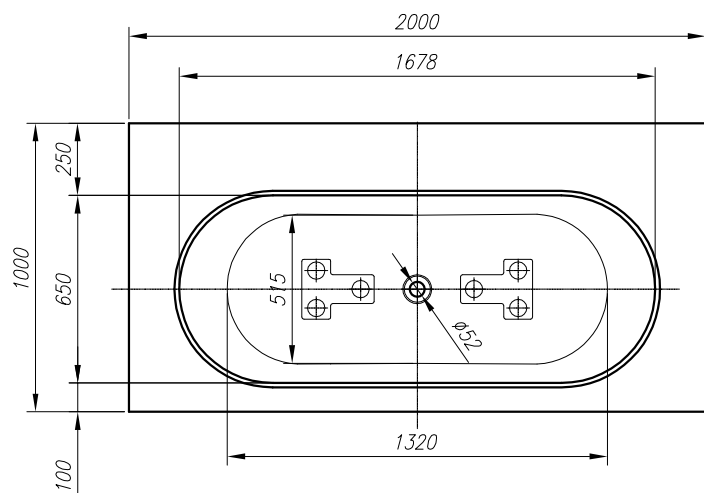
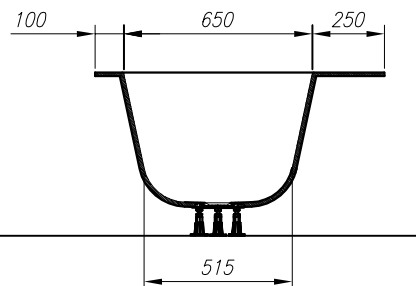
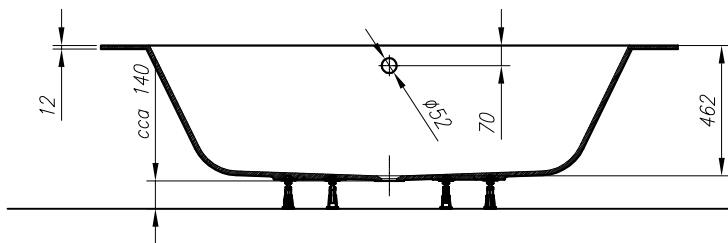
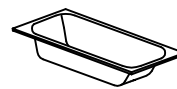

VOLUMEN (l)
VOLUMEN (l)

MAX. OBREMNITEV (Kg)
MAX. OBTEREČENJE (Kg)

OBREMNITEV TAL (Kg/m²)
OBTEREČENJE PODA (Kg/m²)

225

410

300

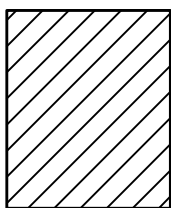

- Prostor za odtok \varnothing 50 mm
- Mjesto za odtok \varnothing 50 mm

- Prostor za priključak tople in hladne vode 1/2" min 0,2 Mpa, max 0,4 Mpa
- Mjesto za priključak tople i hladne vode 1/2" min 0,2 Mpa, max 0,4 Mpa



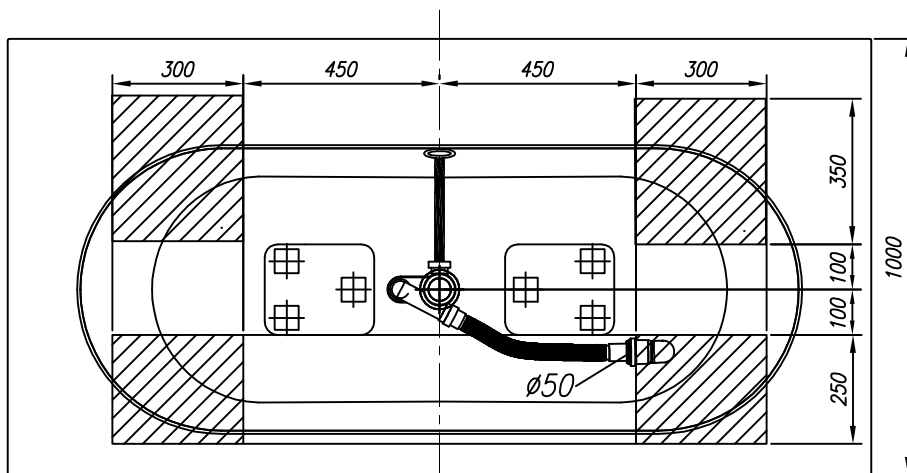

PREDLOG VGRADNJE
PRIJEDLOG UGRADNJE

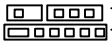

Kopalna kad iz KERROCK-a,
Kada za kupanje iz KERROCK-a

ATYS 200x100

**POLOŽAJ STIKAL IN AGREGATOV PRI RAZLIČNIH IZVEDBAH MASAŽNIH SISTEMOV
MJESTO PREKIDAČA I AGREGATA KOT RAZLIČITIH IZVEDBI MASAŽNIH SISTEMA**

- | | | | | |
|--|--|---|--|--|
|  - VODNA ČRPALKA
- CRPKA ZA VODU |  - VODNE ŠOBE
- VODENE MLAZNICE |  - REGULATOR ZRAKA
- REGULATOR ZRAKA |  - ELEKTRONSKA STIKALA
- ELEKTRONSKI PREKIDAČI |  - ARMATURA IN TUŠ ROČICA
- PIPA I TUŠ |
|  - ZRAČNI KOMPRESOR
- ZRAČNI KOMPRESOR |  - ZRAČNA ŠOBA
- ZRAČNA MLAZNICA |  - PNEVMATSKO STIKALO
- PNEVMATSKI PREKIDAČ |  - LUČ ALI CHROMOTERAPIJA
- SVJETLO ILI CHROMOTERAPIJA |  - PREKLOPNIK ZA MIKROŠOBE
- PREKIDAČ ZA MIKROMLAZNICE |

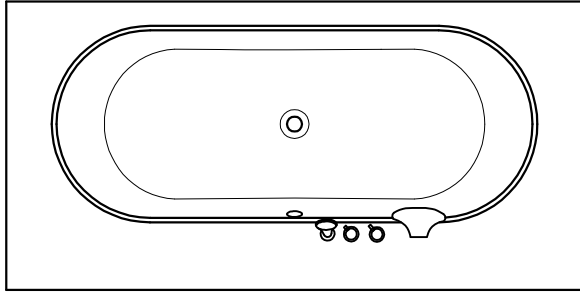

- OPCIJA ARMATURA IN TUŠ ROČICA - OPCIJA PIPA I TUŠ

